

Amanda Coyocari Arquilelura



6,50

3,40

PLANTA SITUAÇÃO ATUAL
ESCALA 1.:20

Área Externa



PLANTA SITUAÇÃO PROPOSTA
ESCALA 1.:20

↑
Área Externa

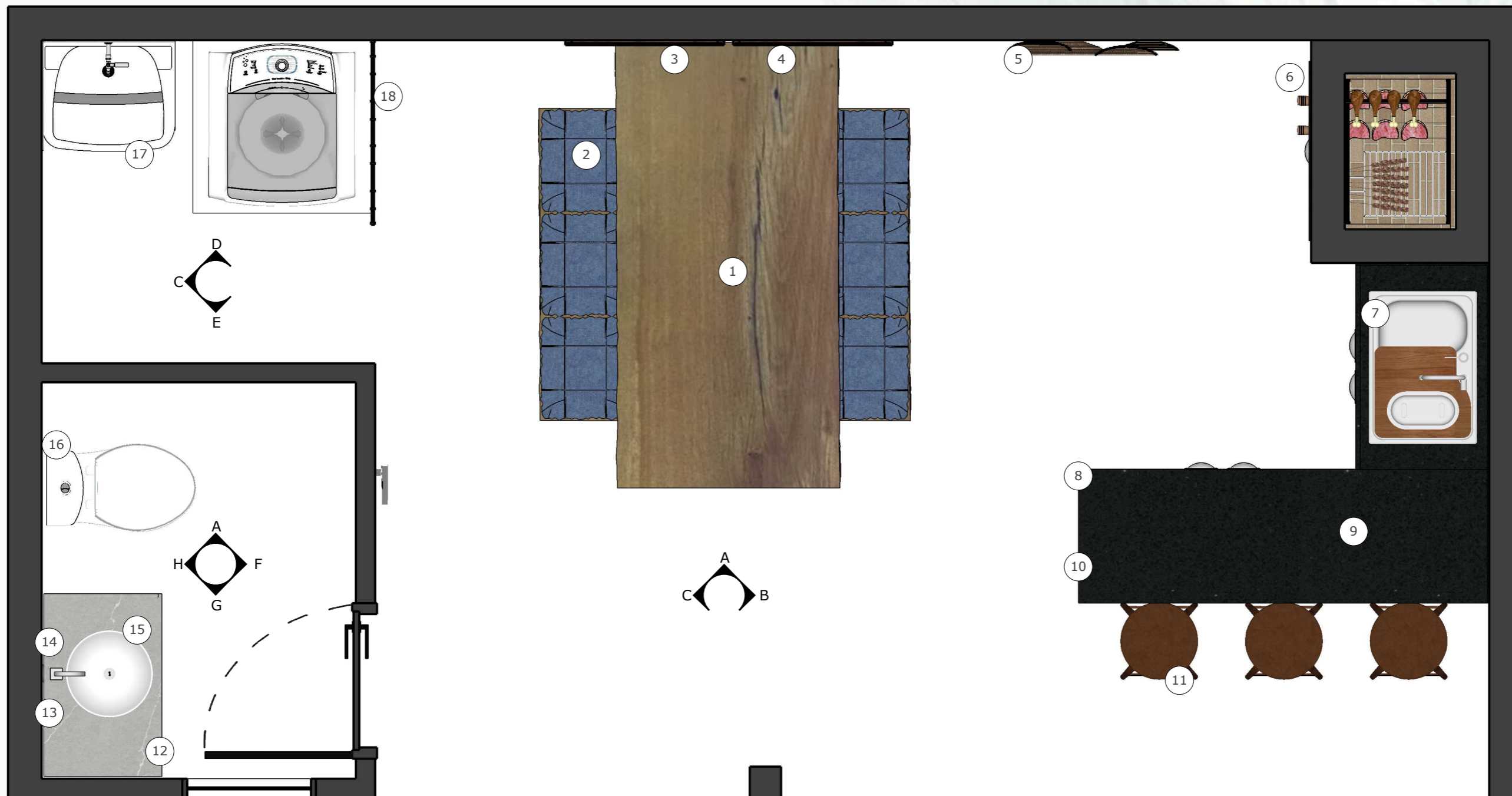

PLANTA LAYOUT
ESCALA 1.:20

- | | | | | |
|---|--|---|--|--|
| ① Mesa madeira maciça (99x220) - Arboreal | ⑤ Bandeja cesta oval em palha - Camicado | ⑨ Bancada pedra Stellar Negro - Silestone | ⑬ Pelicano espelho redondo 60cm | ⑰ Tanque 40L - Deca |
| ② Banco rústico em madeira maciça (40x140) - Arboreal | ⑥ Churrasqueira em alvenaria - ver det. | ⑩ Revestimento Korea para bancada - Ceusa | ⑭ Torneira de mesa bica alta para lavatório - Deca | ⑱ Divisória cobogó - a definir (cerâmico ou chapa perfurada) |
| ③ Quadro folhagem multicolor (70x98) - Galeria9 | ⑦ Cuba de sobrepor Tramontina morgana 60fx em aço inox - Tamontina | ⑪ Banquetas estilo industrial | ⑮ Cuba de apoio redonda L.55 branca - Deca | |
| ④ Quadro braços floridos (70x98) - Galeria9 | ⑧ Bancada em alvenaria - ver det. | ⑫ Bancada pedra Et Serena - Silestone | ⑯ Bacia para caixa acoplada ravena - Deca | |

Legenda:

- | | | |
|---------|---------|---------|
| Vista A | Vista D | Vista G |
| Vista B | Vista E | Vista H |
| Vista C | Vista F | |



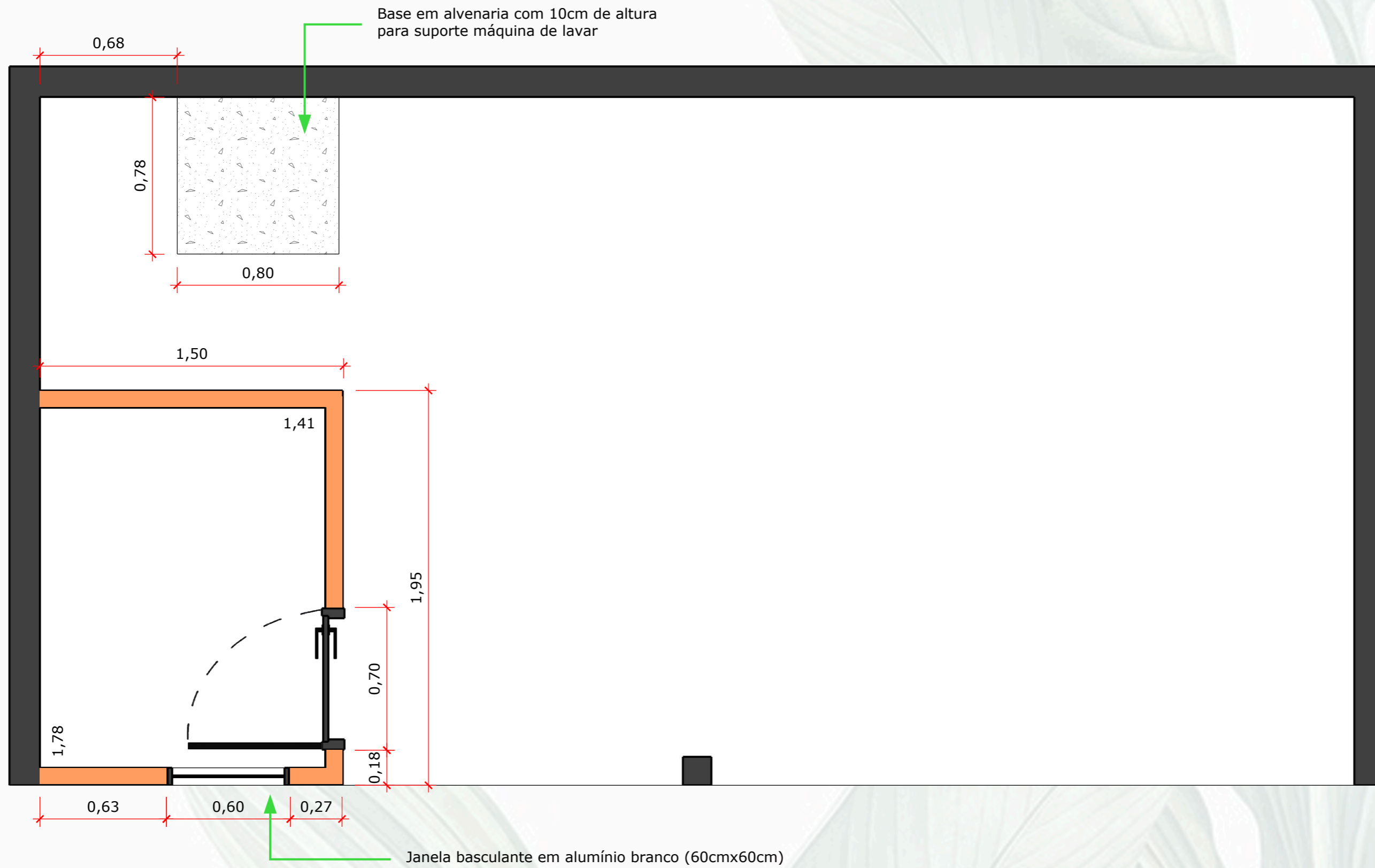

PLANTA CONSTRUIR/DEMOLIR
 ESCALA 1.:20

Legenda:

 Base em alvenaria

 Paredes novas a serem construídas

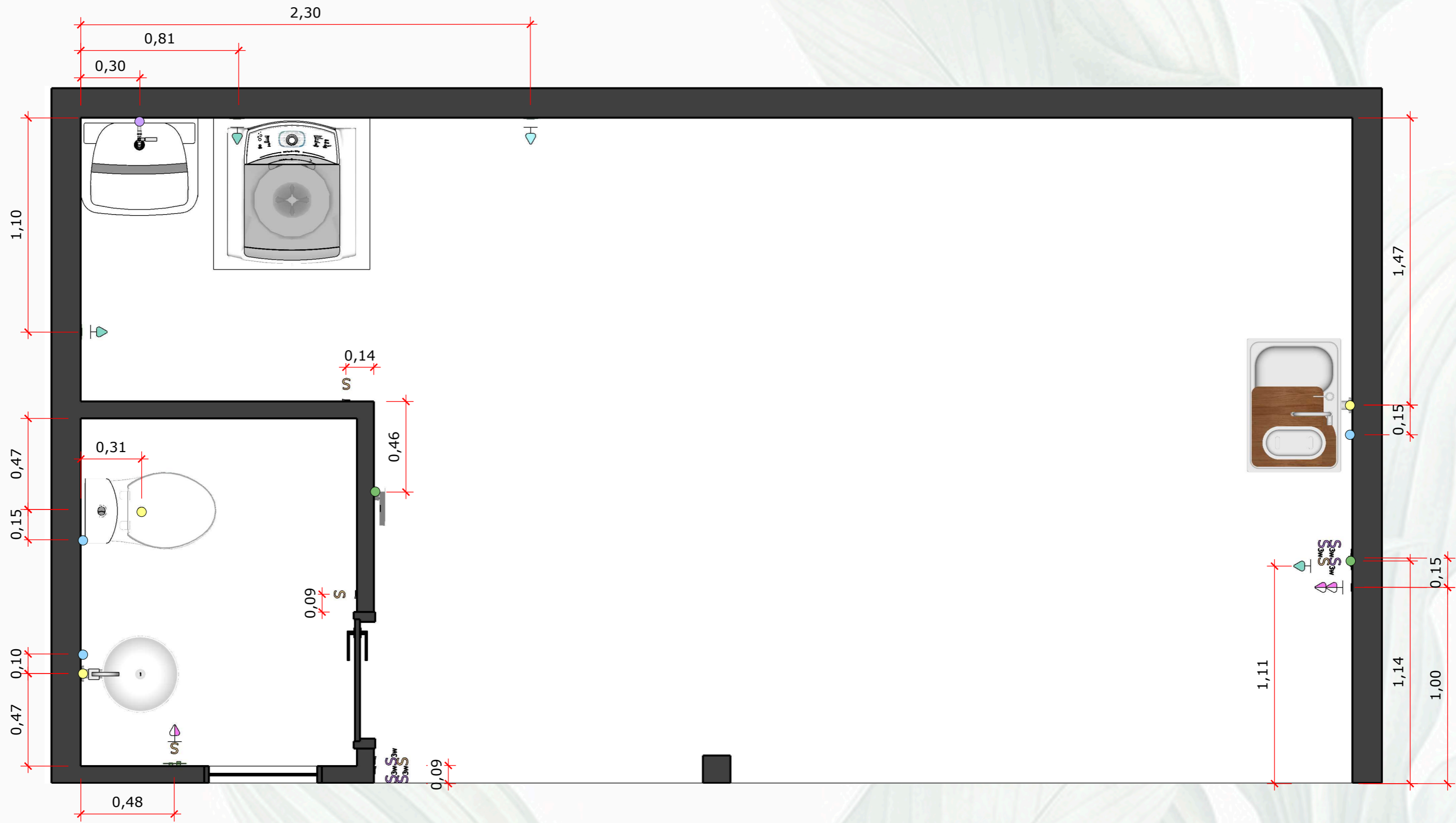

PLANTA PONTOS ELÉTRICOS E HIDRÁULICOS
 ESCALA 1.:20

*** Conferir altura de interruptores e tomadas de acordo com as vistas detalhadas de pontos elétricos**

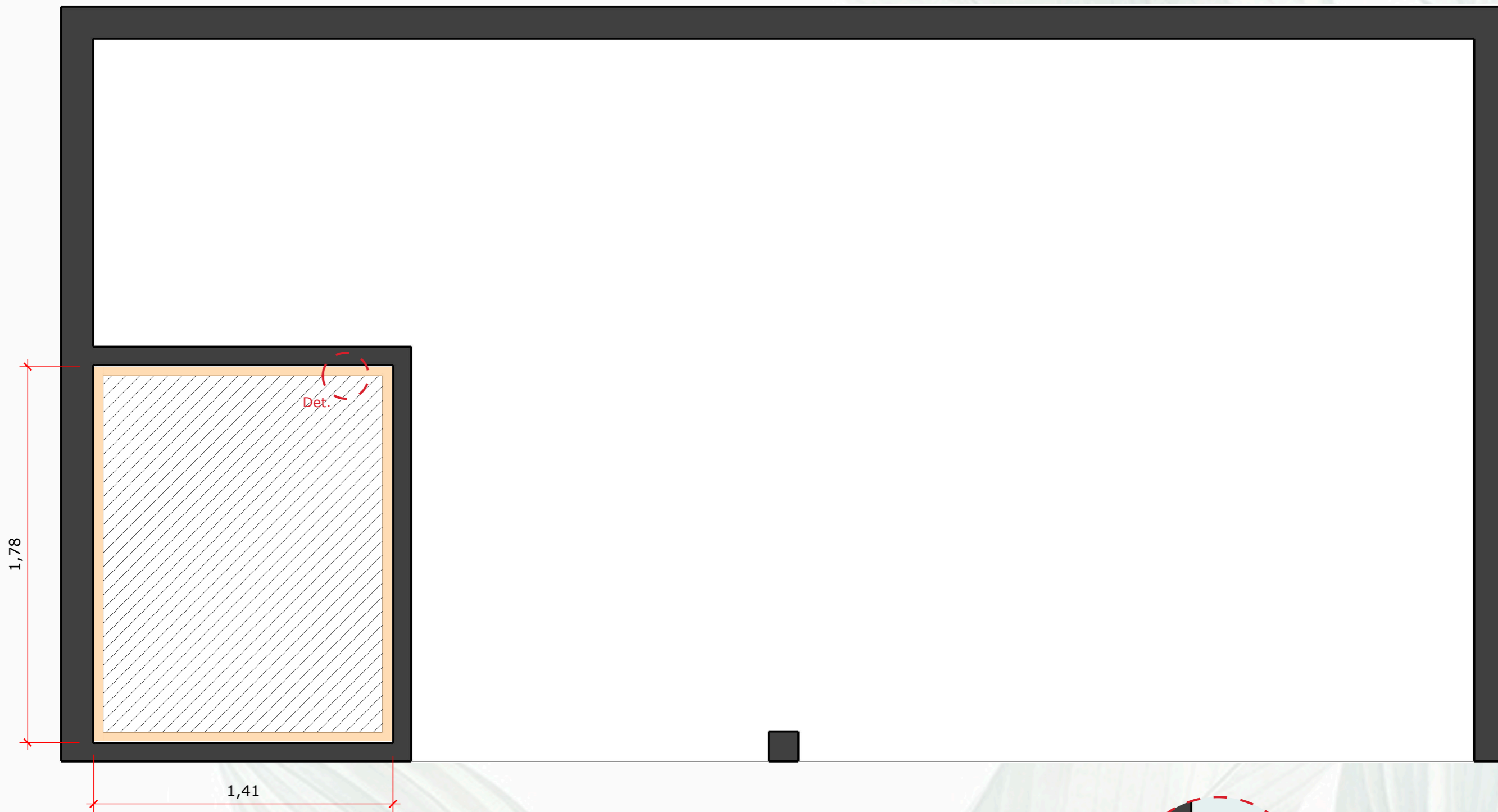

- Legenda:
- Ponto de água/ esgoto existente
 - Ponto de água
 - Ponto de esgoto
 - Interruptor simples
 - Interruptor paralelo
 - Tomada baixa 220v existente
 - Tomada baixa 127v
 - Tomada média 127v
 - Ponto passagem de fio - arandela/ fita de led

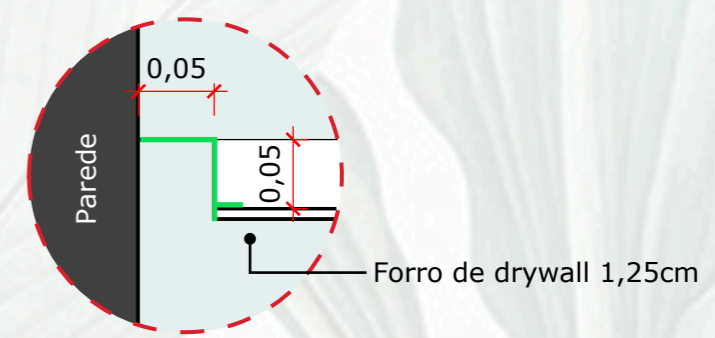

PLANTA FORRO DRYWALL
ESCALA 1.:20

DETALHE FORRO DRYWALL LAVABO
ESCALA 1.:5





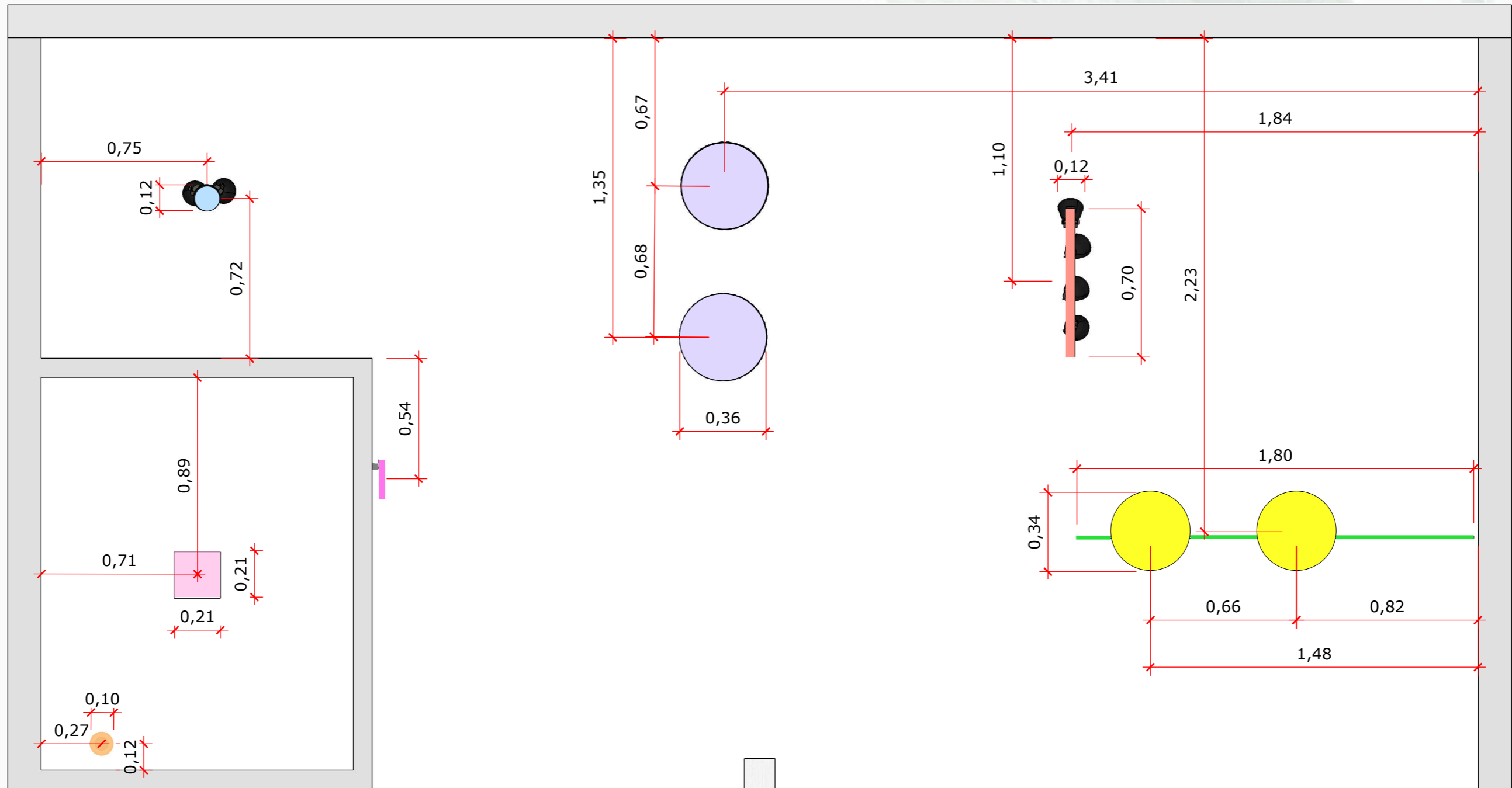





- Legenda:
-  Forro de drywall - somente no lavabo
 -  Tabica 5cm
 -  Tabica



PLANTA DE ILUMINAÇÃO
ESCALA 1.:20

*** Conferir posicionamento dos pendentes de acordo com estrutura presente do telhado**

Legenda:

- | | |
|--|--|
|  Plafon sobrepor alumínio branco |  Pendente Juta Of White |
|  Pendente vidro alumínio orbit |  Pendente preto branco Ip55 space |
|  Spot sobrepor alumínio preto 9cm |  Spot sobrepor quadruplo alumínio |
|  Arandela alumínio branco led 24w |  Fita de led 2835 12v - 4,8 watts |

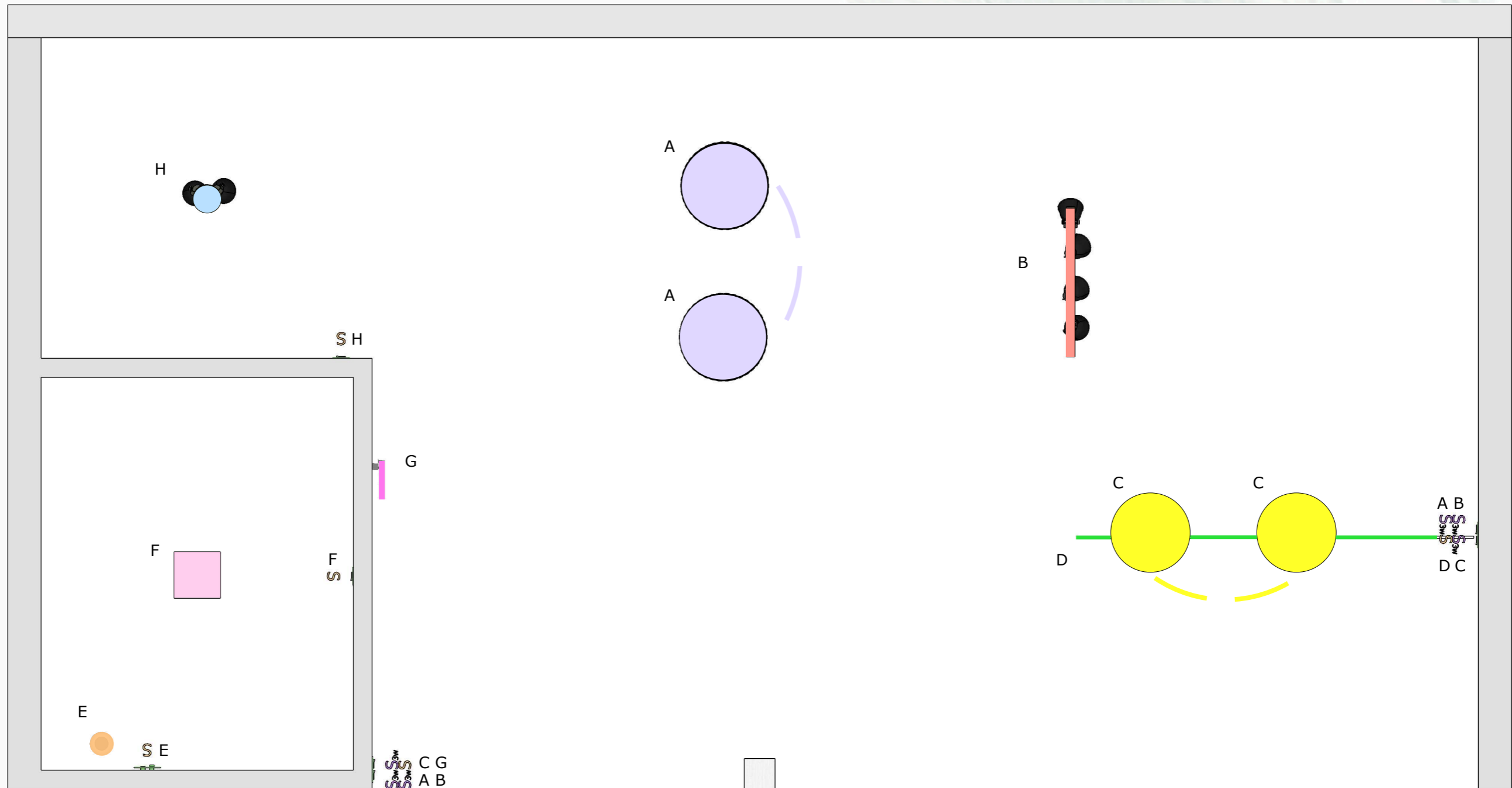

PLANTA DE CIRCUITOS
ESCALA 1.:20

* Nomenclaturas já de acordo com os seus respectivos módulos:

- S Interruptor simples
- S_{3w} Interruptor paralelo

* Fita de Led (D) e Arandela (G) possuem interruptor simples

* Fita de Led com fonte na tomada acionada no interruptor

Imagem referencial:

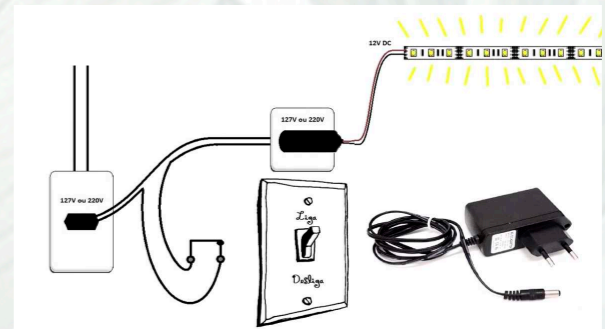

Legenda:

- Plafon sobrepor alumínio branco
- Pendente vidro alumínio orbit
- Spot sobrepor alumínio preto 9cm
- Arandela alumínio branco led 24w
- Pendente Juta Of White
- Pendente preto branco Ip55 space
- Spot sobrepor quadruplo alumínio
- Fita de led 2835 12v - 4,8 watts

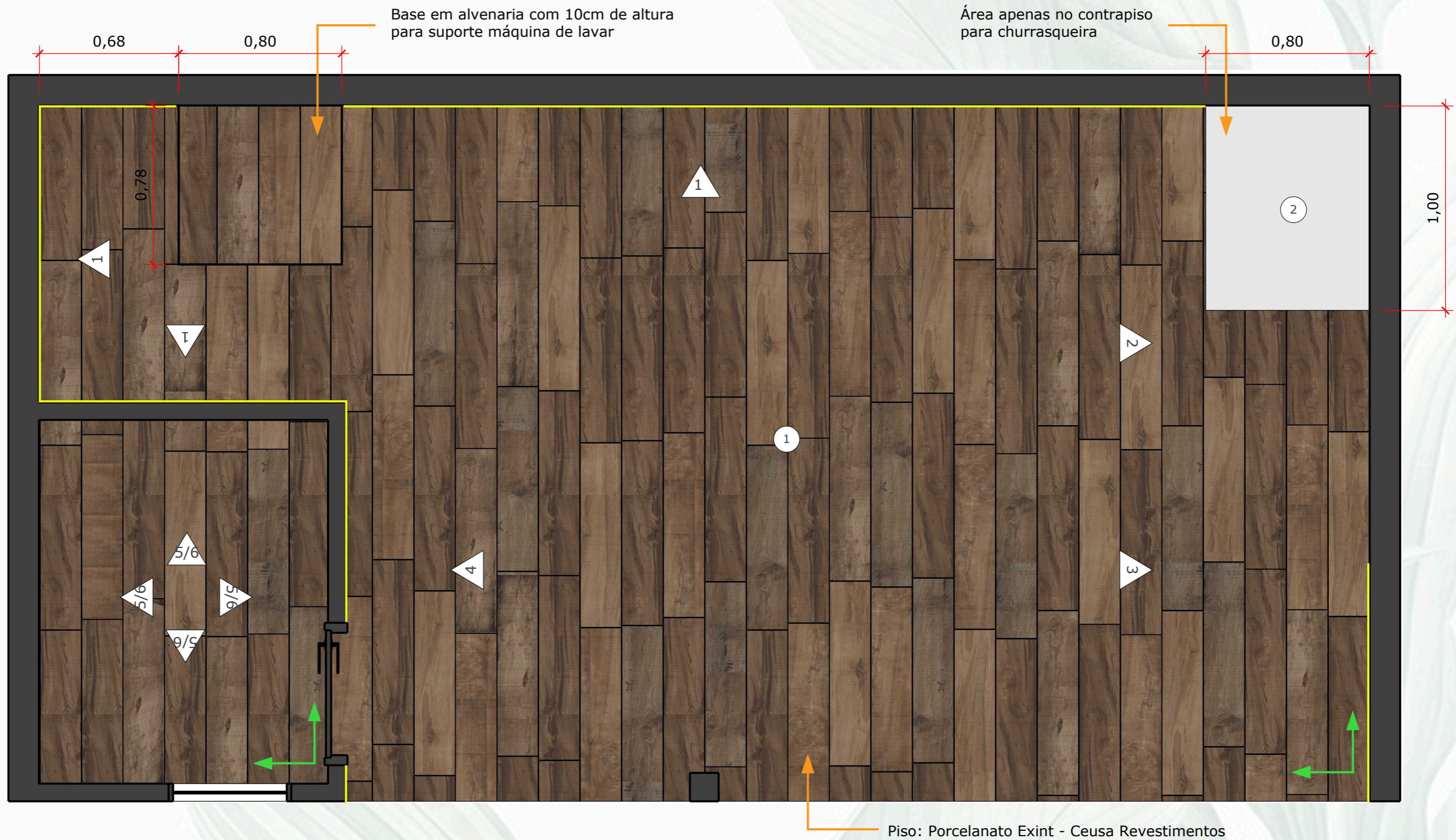

PLANTA PAGINAÇÃO DE PISO
ESCALA 1.:20

*** Conferir dimensões exatas dos revestimentos/ pintura das paredes de acordo com as vistas**

Legenda:

↗ Início da paginação

■ Rodapé de poliestireno branco (10x24)cm uni.

① Porcelanato Extint

② Reboco

① Tinta Suvinil efeito rústico vento sul

② Reboco

③ Brick Branco

④ Tinta Suvinil cimento queimado dia de chuva

⑤/⑥ - Tinta Suvinil toque de luz verde vítreo - Revestimento Invertido branco

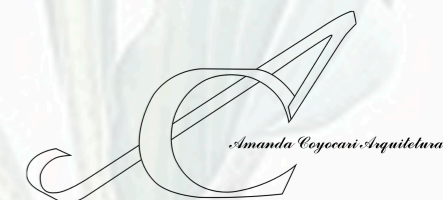









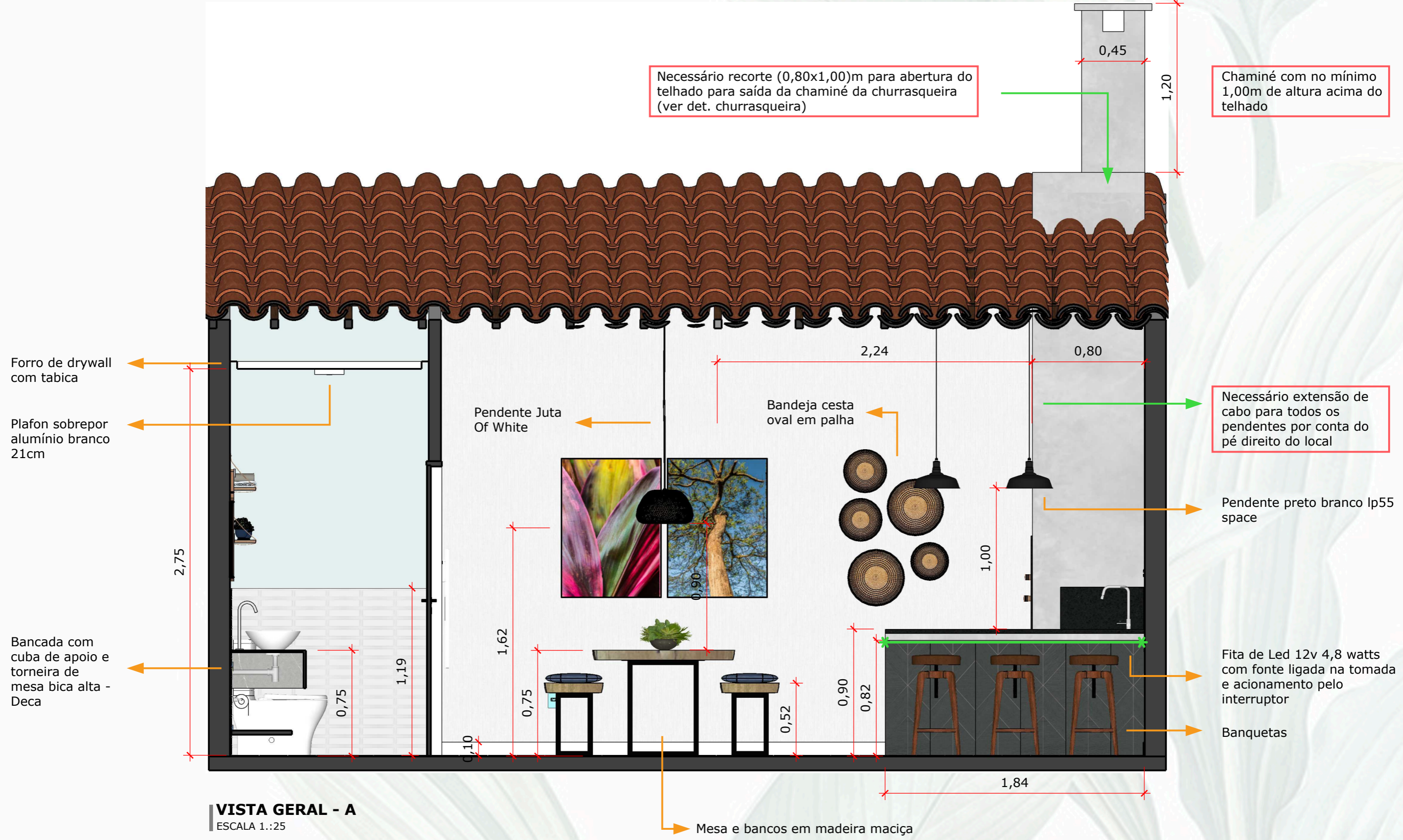



- Legenda:**
-  Fita de Led 12v 4,8 watts
 -  Tomada existente 220v

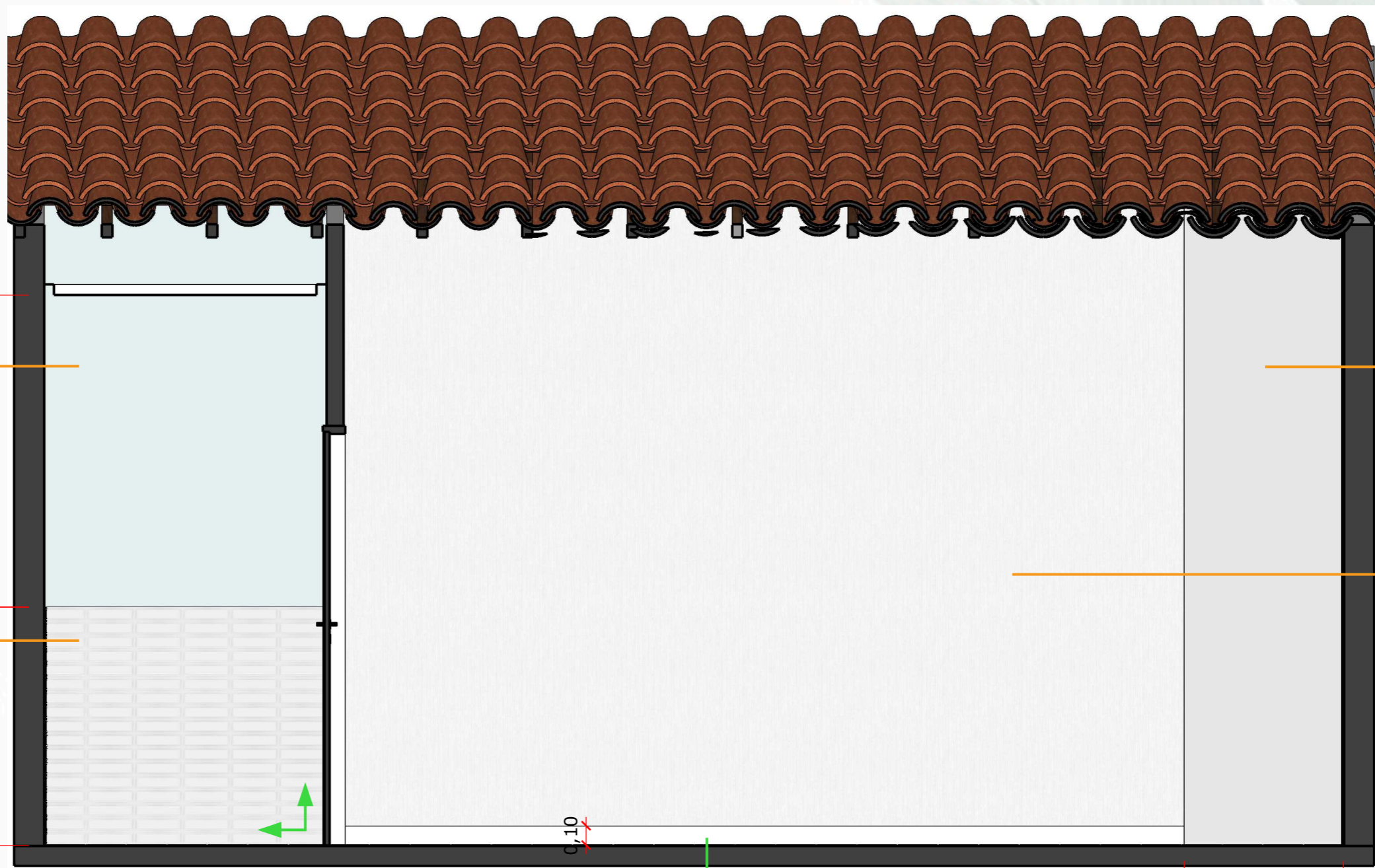

Tinta Suvinil toque de luz verde vítreo

1,56

Revestimento invertido branco - Ceusa

1,19

Acabamento apenas no reboco para recebimento da churrasqueira

Tinta Suvinil efeito rústico vento sul

Rodapé em poliestireno

0,80

0,10

VISTA REVESTIMENTOS - A

ESCALA 1.:25

Legenda:

↻ Início da paginação



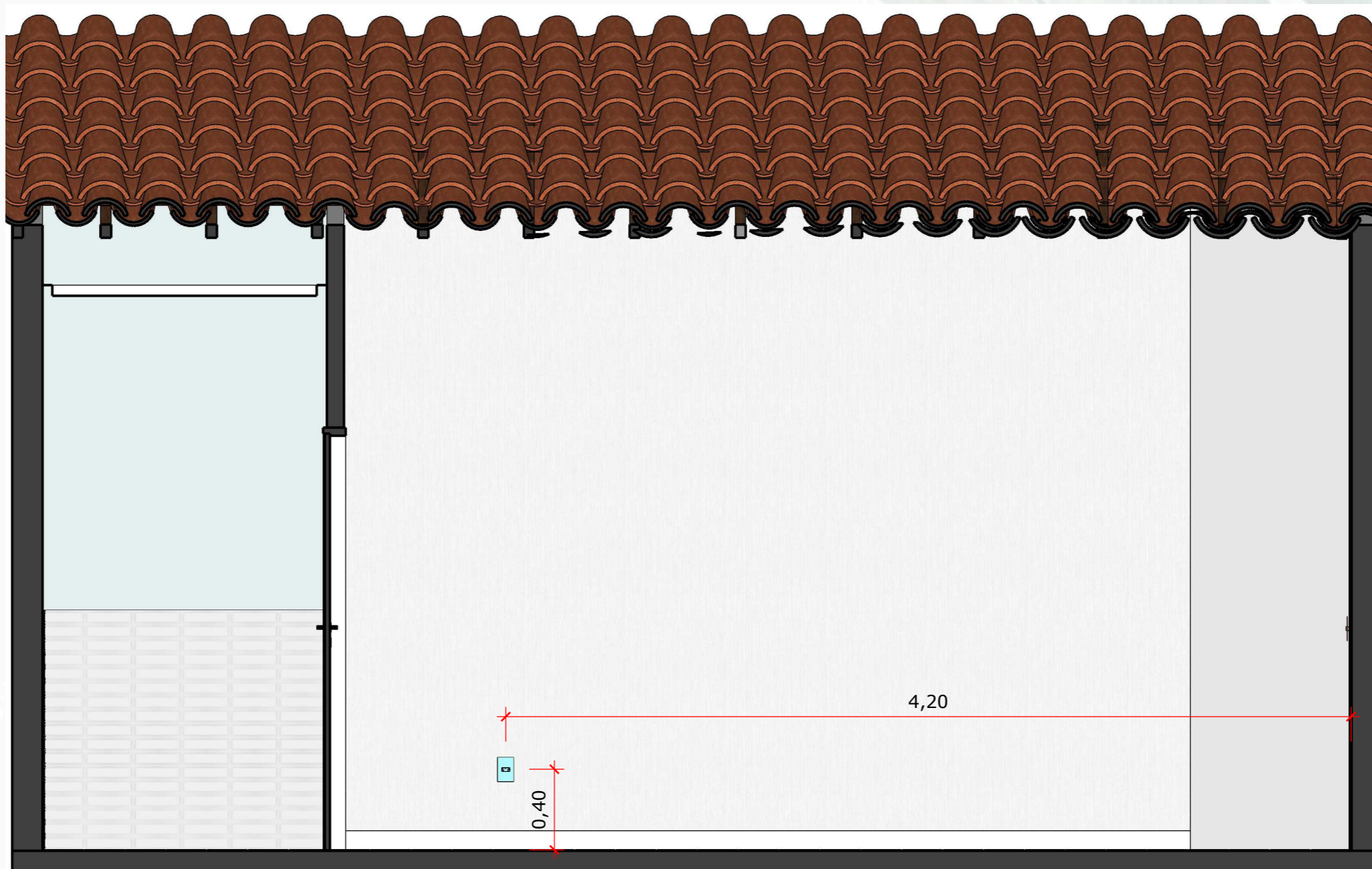

VISTA PONTOS TÉCNICOS - A
ESCALA 1.:25

Legenda:

 Tomada existente 220v

Chaminé com no mínimo 1,00m de altura acima do telhado

Necessário recorte (0,80x1,00)m para abertura do telhado para saída da chaminé da churrasqueira (ver det. churrasqueira)

Spot sobrepor quadruplo alumínio preto



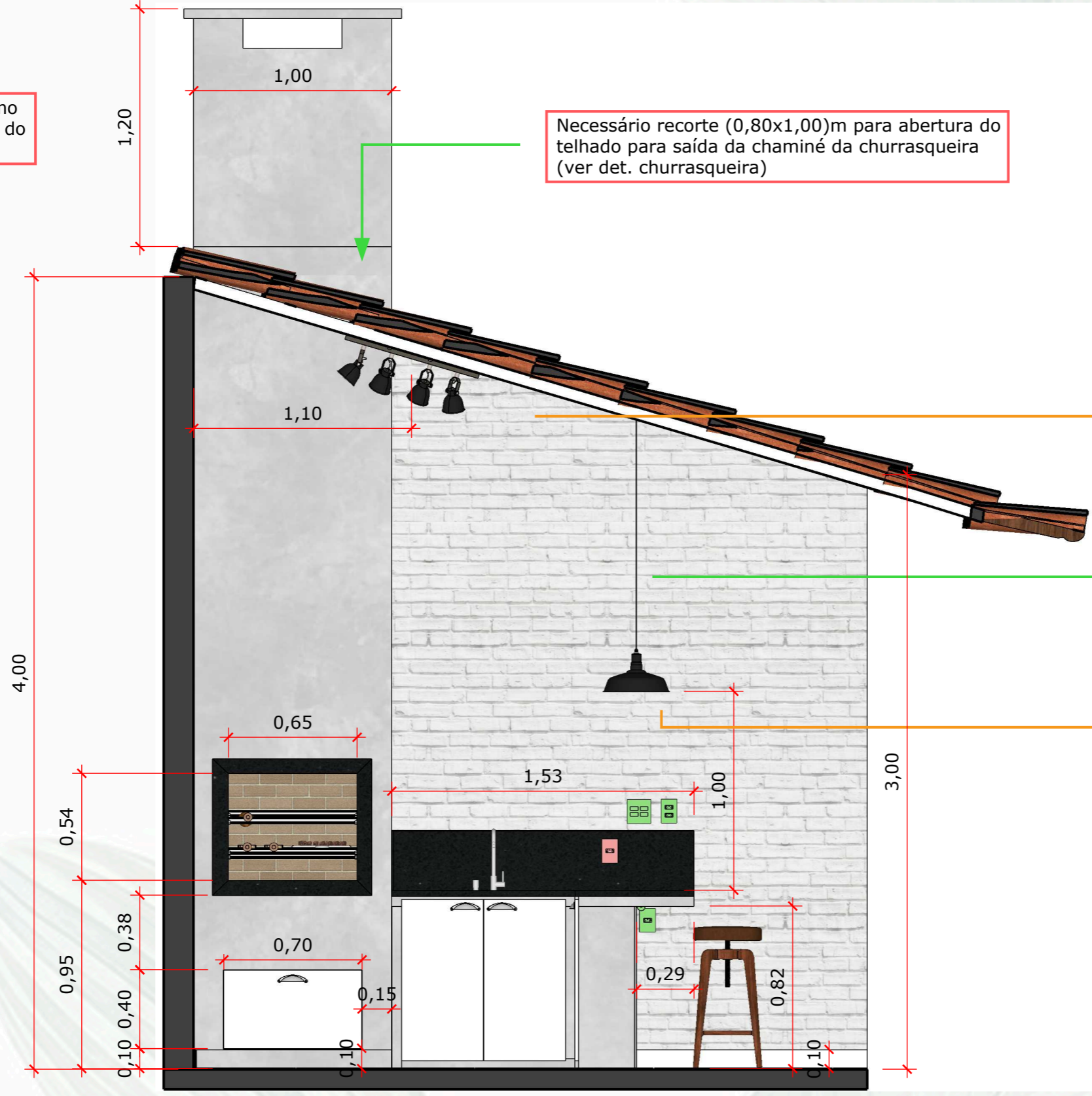

Necessário extensão de cabo para todos os pendentis por conta do pé direito do local

Pendente preto branco lp55 space



VISTA GERAL - B
ESCALA 1.:25

Legenda:

-  Tomada existente a realocar
-  Tomada 1 módulo nova
-  Tomada 2 módulos nova
-  Interruptor 3 módulos paralelos e 1 módulo simples nova

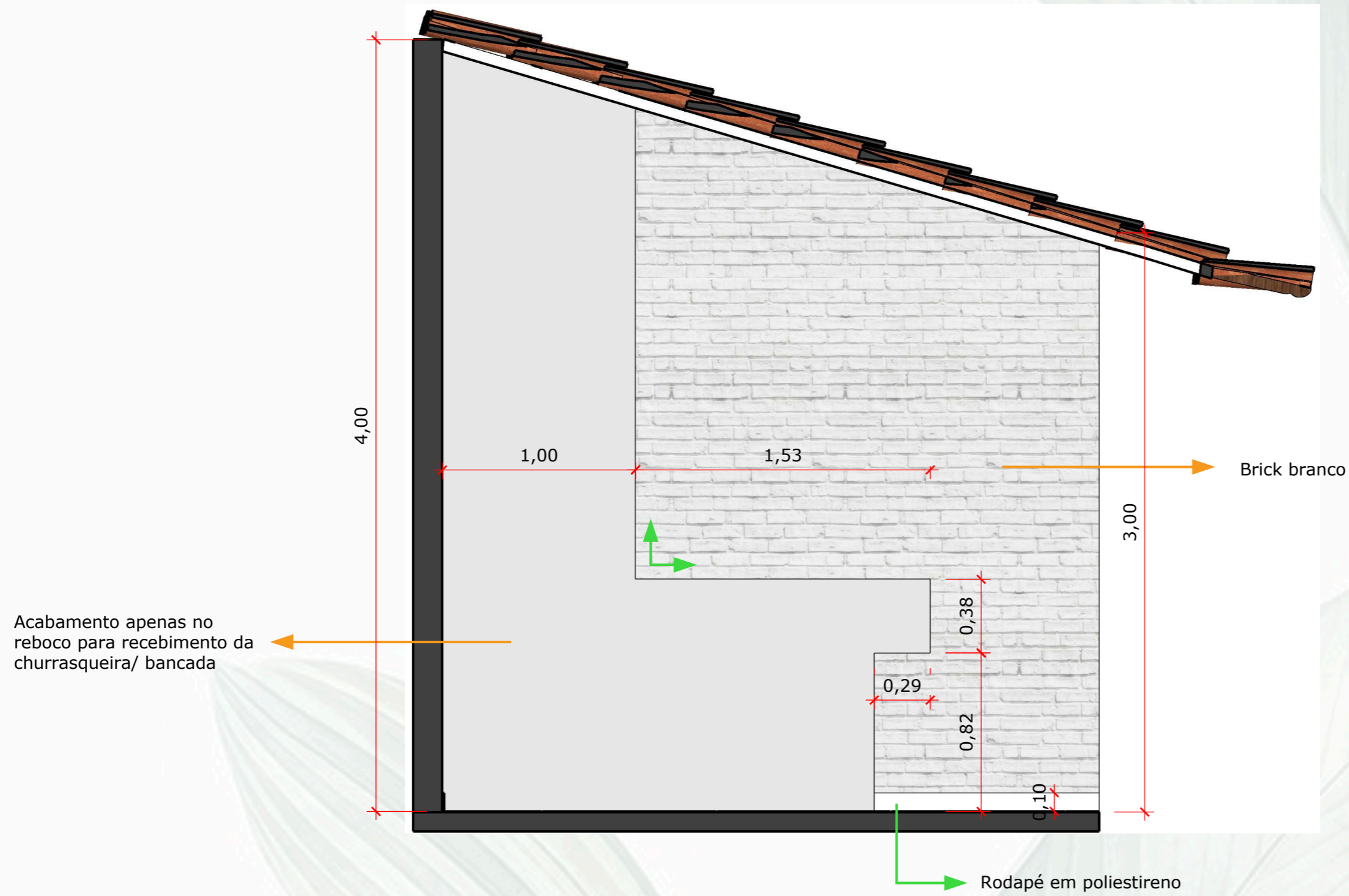

VISTA REVESTIMENTOS - B
 ESCALA 1.:25

Legenda:
 Início da paginação

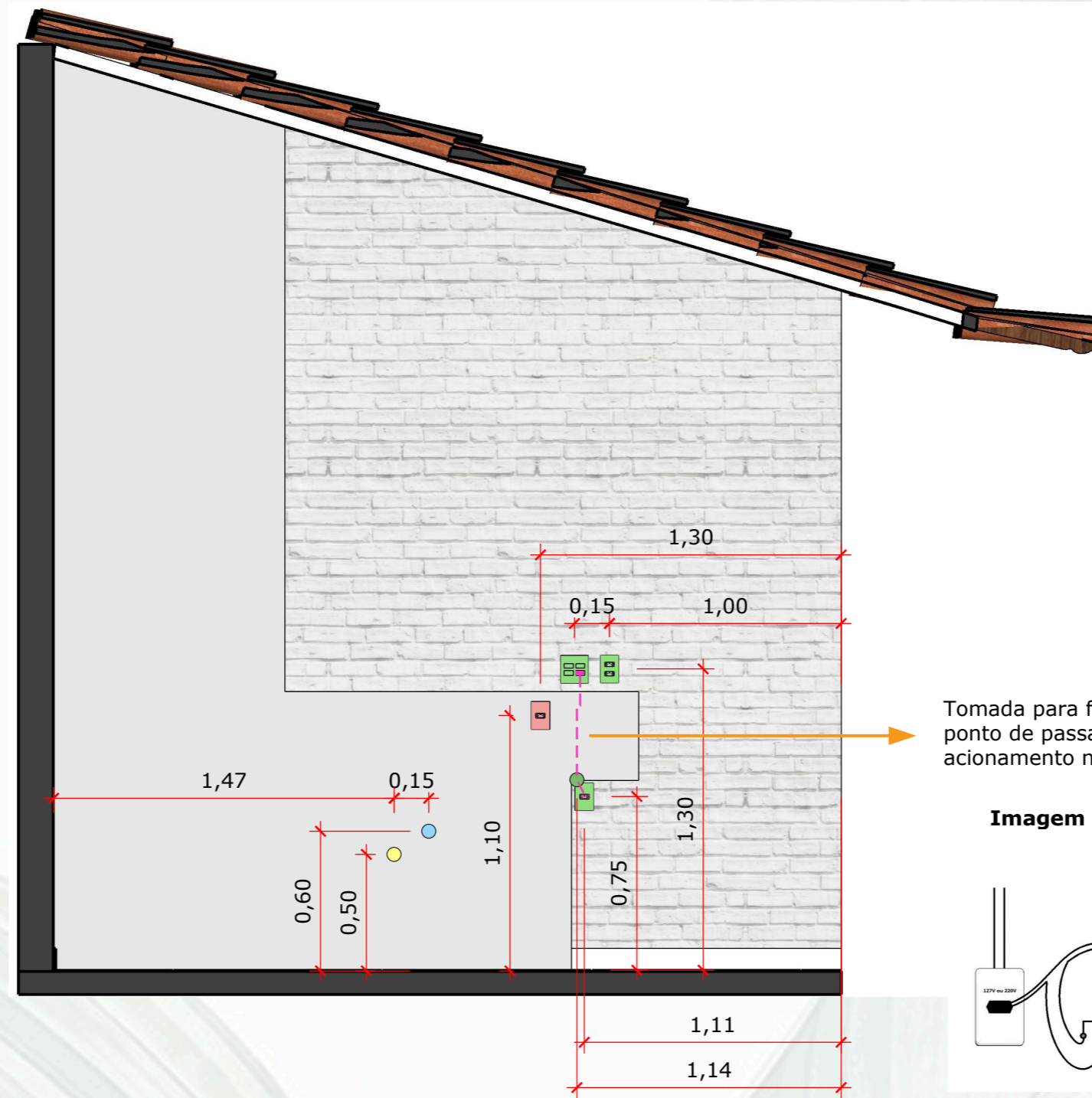



Tomada para fonte da fita de led junto ao ponto de passagem da fiação para acionamento no interruptor

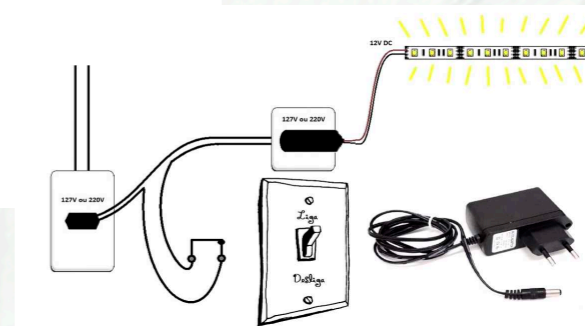



Imagem referencial:



VISTA PONTOS TÉCNICOS - B
ESCALA 1.:25

Legenda:

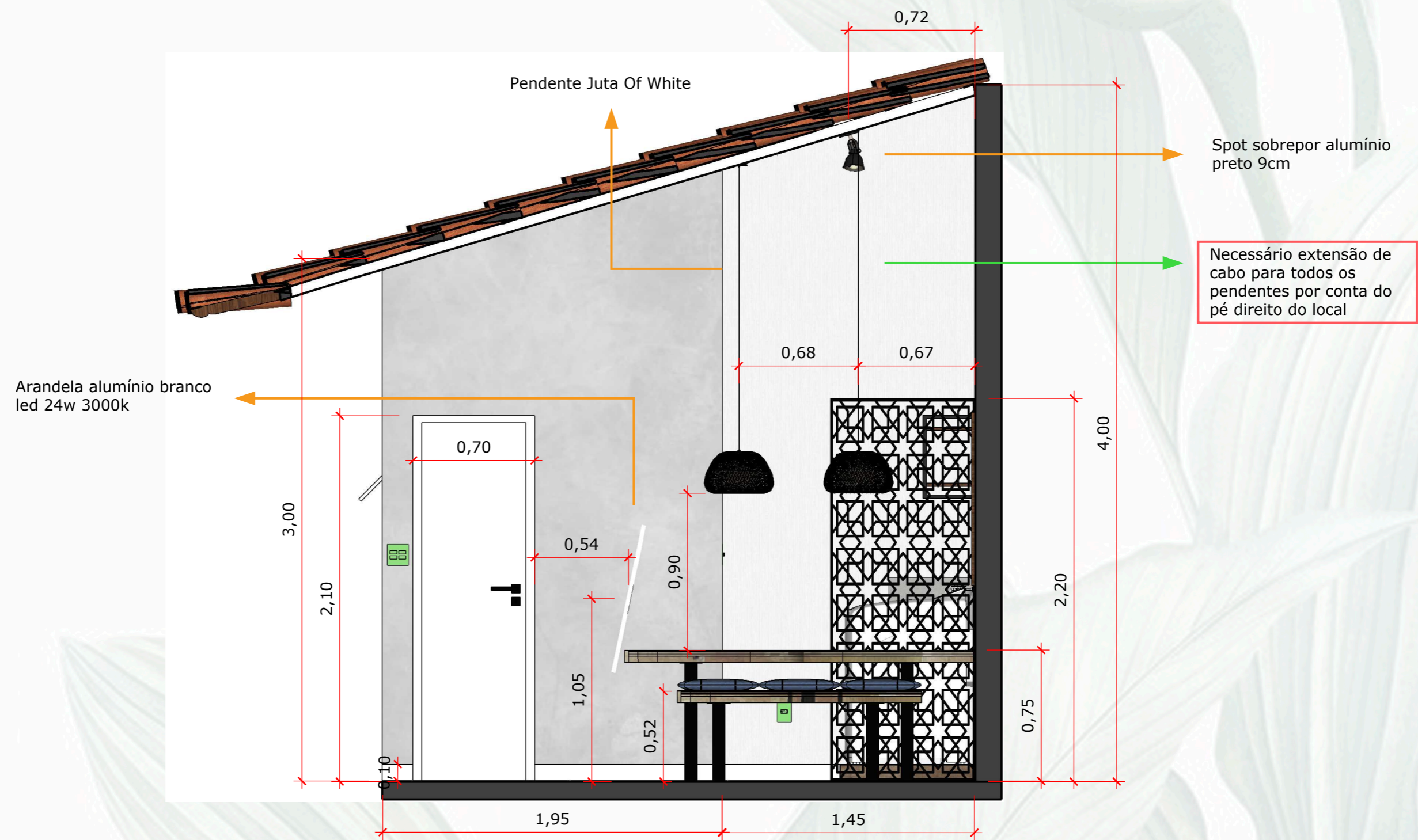

-  Tomada existente a realocar
-  Tomada 1 módulo nova
-  Tomada 2 módulos nova

-  Interruptor 3 módulos paralelos e 1 módulo simples nova
-  Ponto de água
-  Ponto de esgoto
-  Ponto passagem de fio - arandela/ fita de led
-  Percuso para acionamento fita de led



VISTA GERAL - C
 ESCALA 1.:25

Legenda:

-  Interruptor 3 módulos paralelos e 1 módulo simples nova
-  Tomada 1 módulo nova



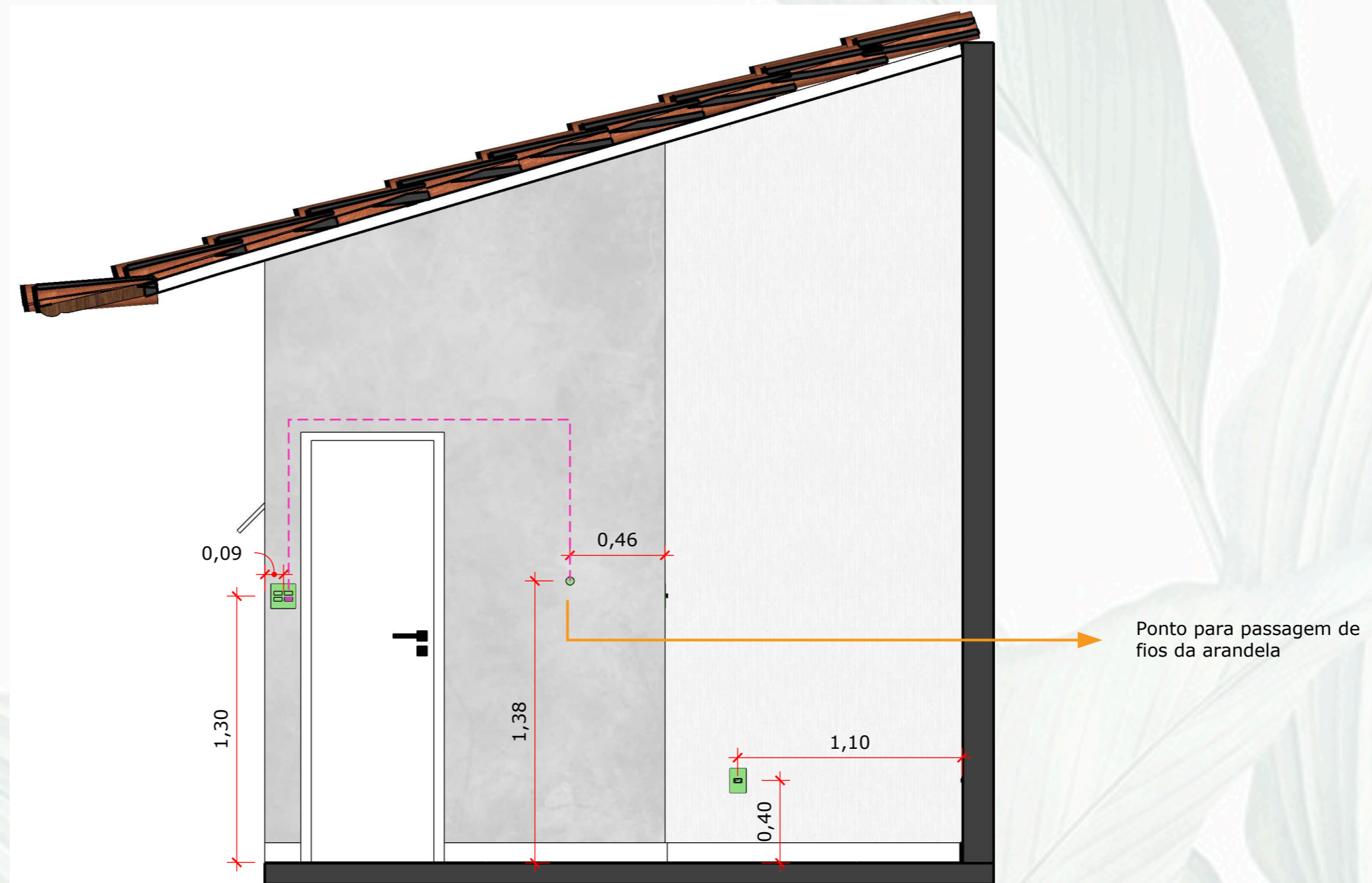

VISTA REVESTIMENTOS - C
ESCALA 1.:25



VISTA PONTOS TÉCNICOS - C
 ESCALA 1.:25

Legenda:

- 
Interruptor 3 módulos paralelos e 1 módulo simples nova
- 
Tomada 1 módulo nova
- 
Percuso para acionamento arandela



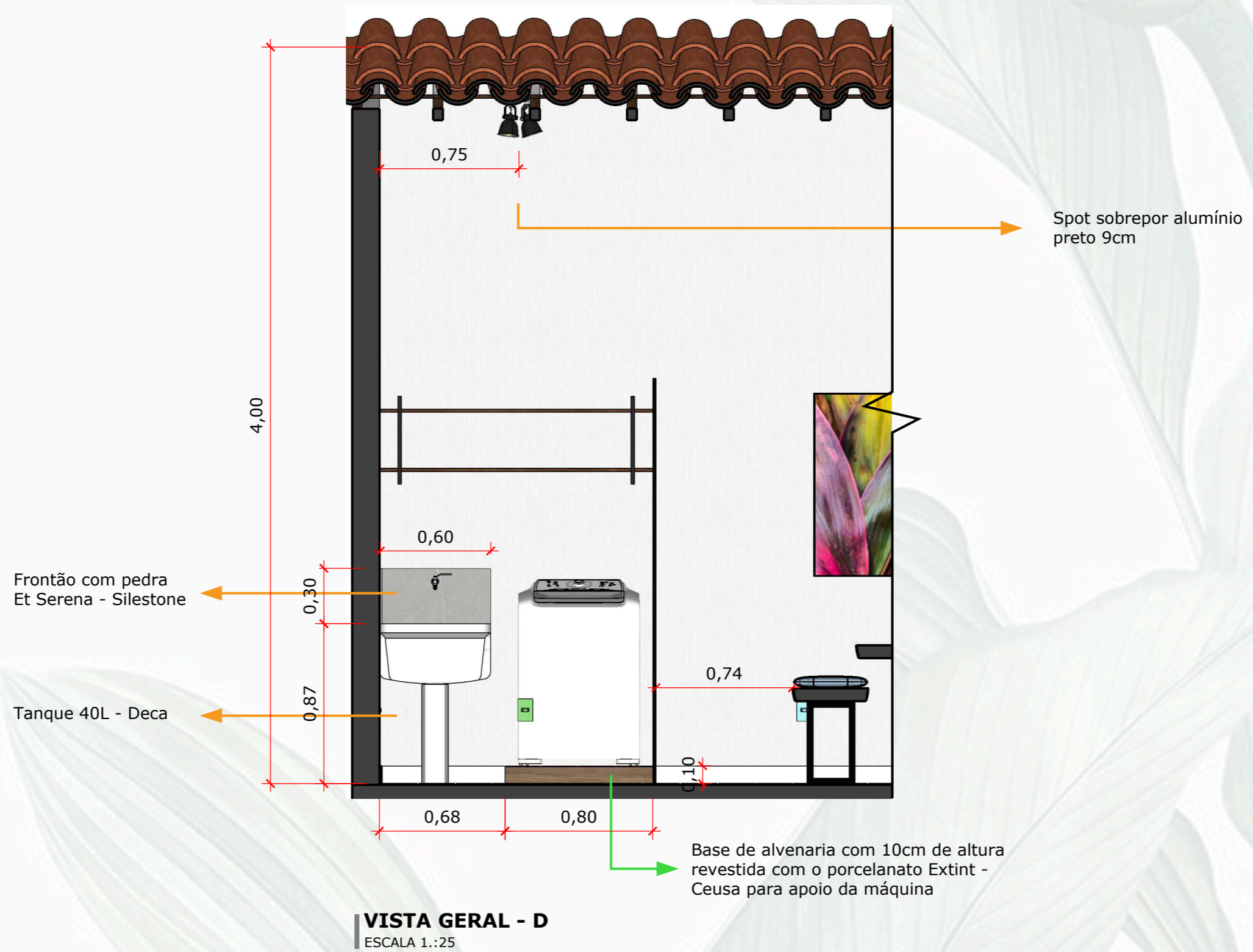

Legenda:

 Tomada 1 módulo nova

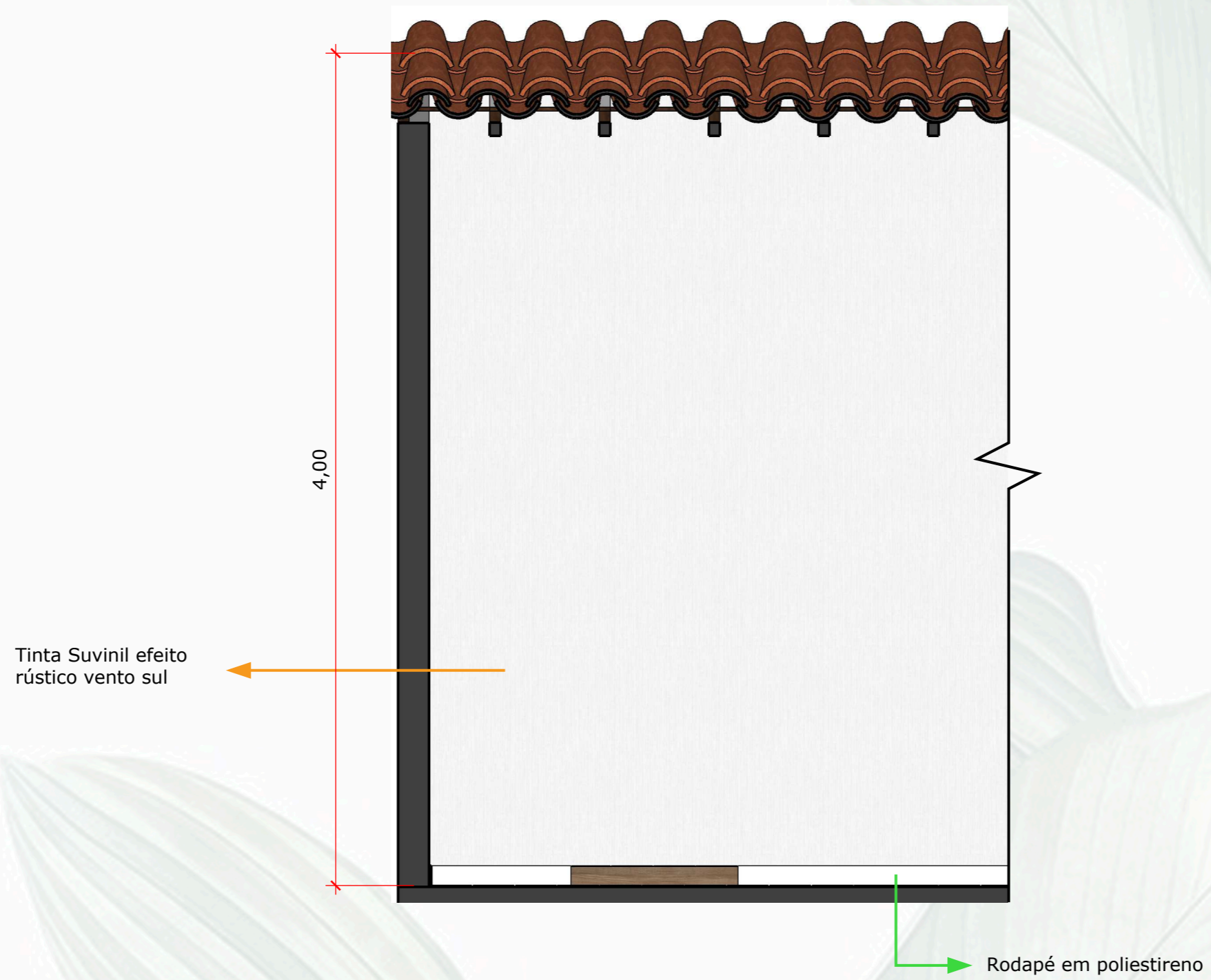

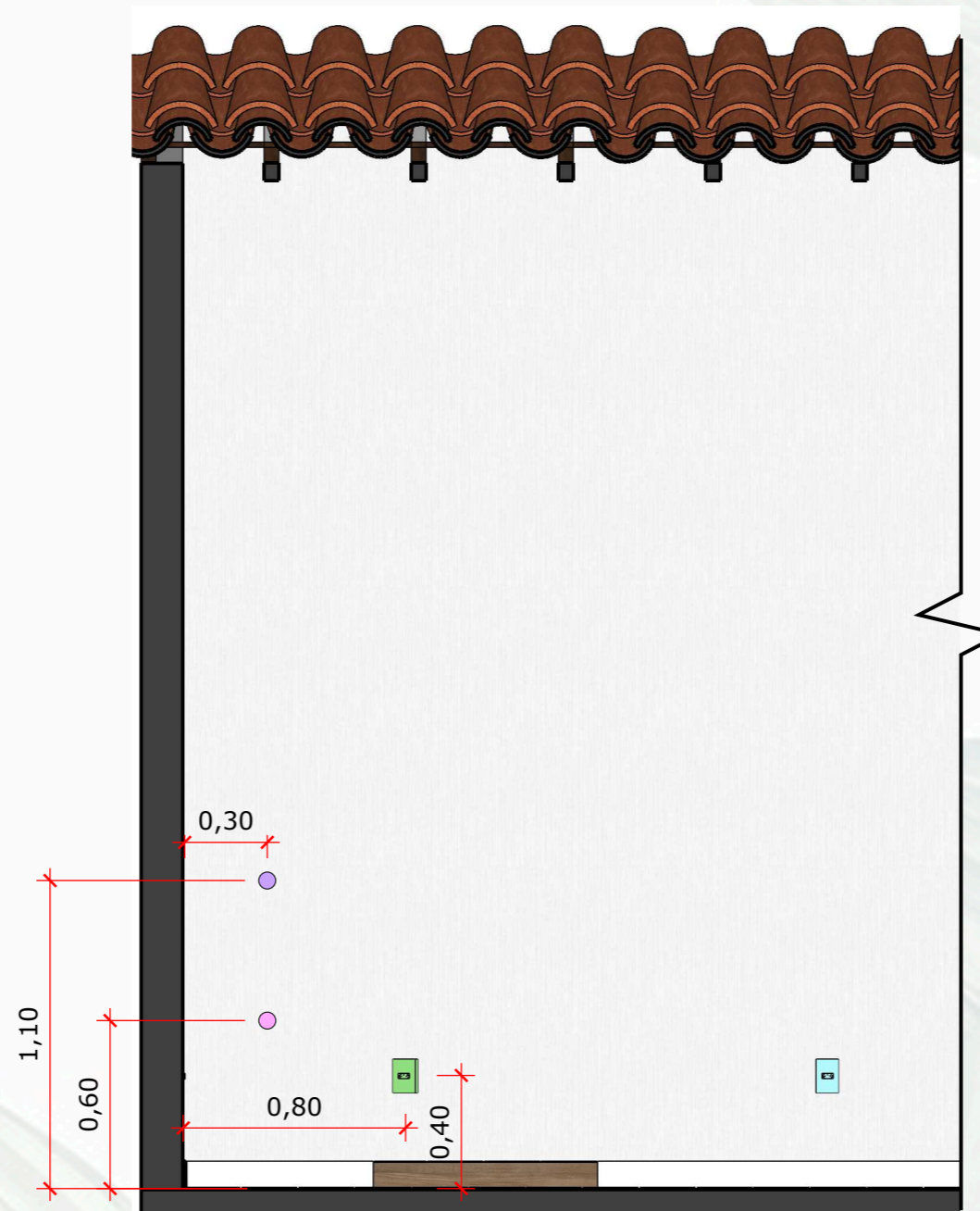

VISTA REVESTIMENTOS - D
ESCALA 1.:25



VISTA PONTOS TÉCNICOS - D
 ESCALA 1.:25

Legenda:

-  Tomada 1 módulo nova
-  Ponto de água existente
-  Ponto de esgoto existente

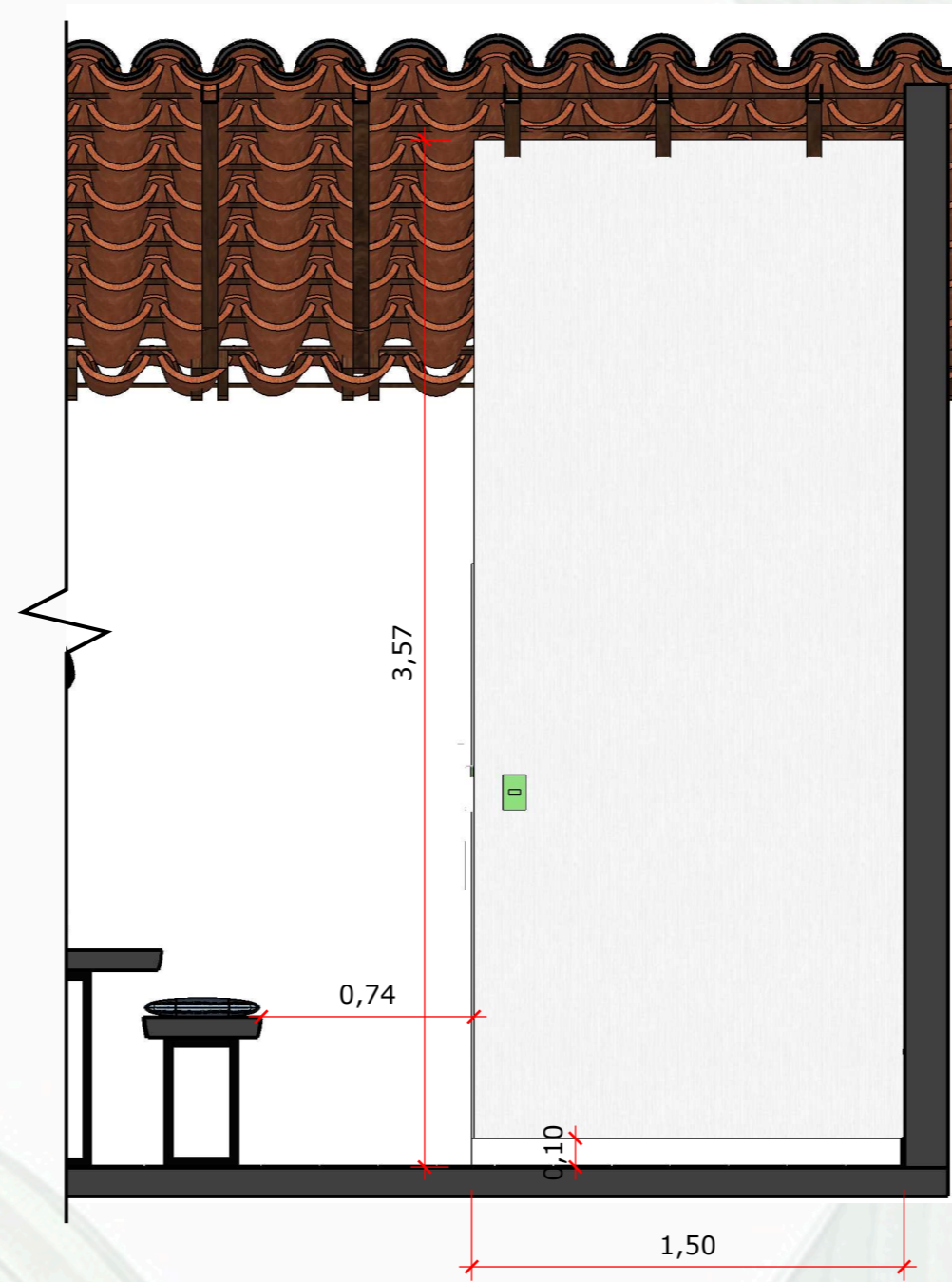

VISTA GERAL - E
ESCALA 1.:25

Legenda:

 Interruptor 1 módulo nova

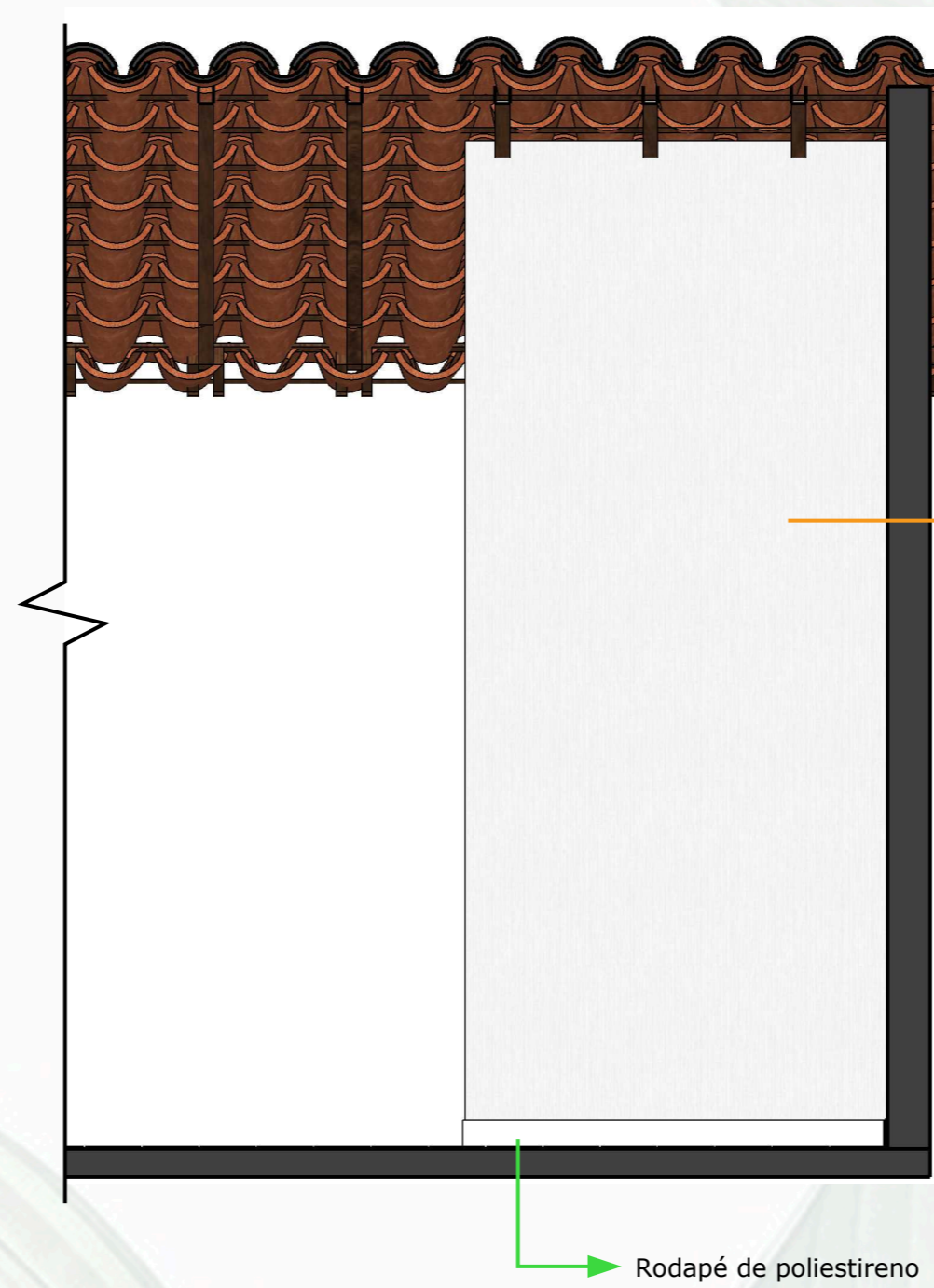

Tinta Suvinil efeito rústico vento sul

Rodapé de poliestireno

VISTA REVESTIMENTOS - E
ESCALA 1.:25

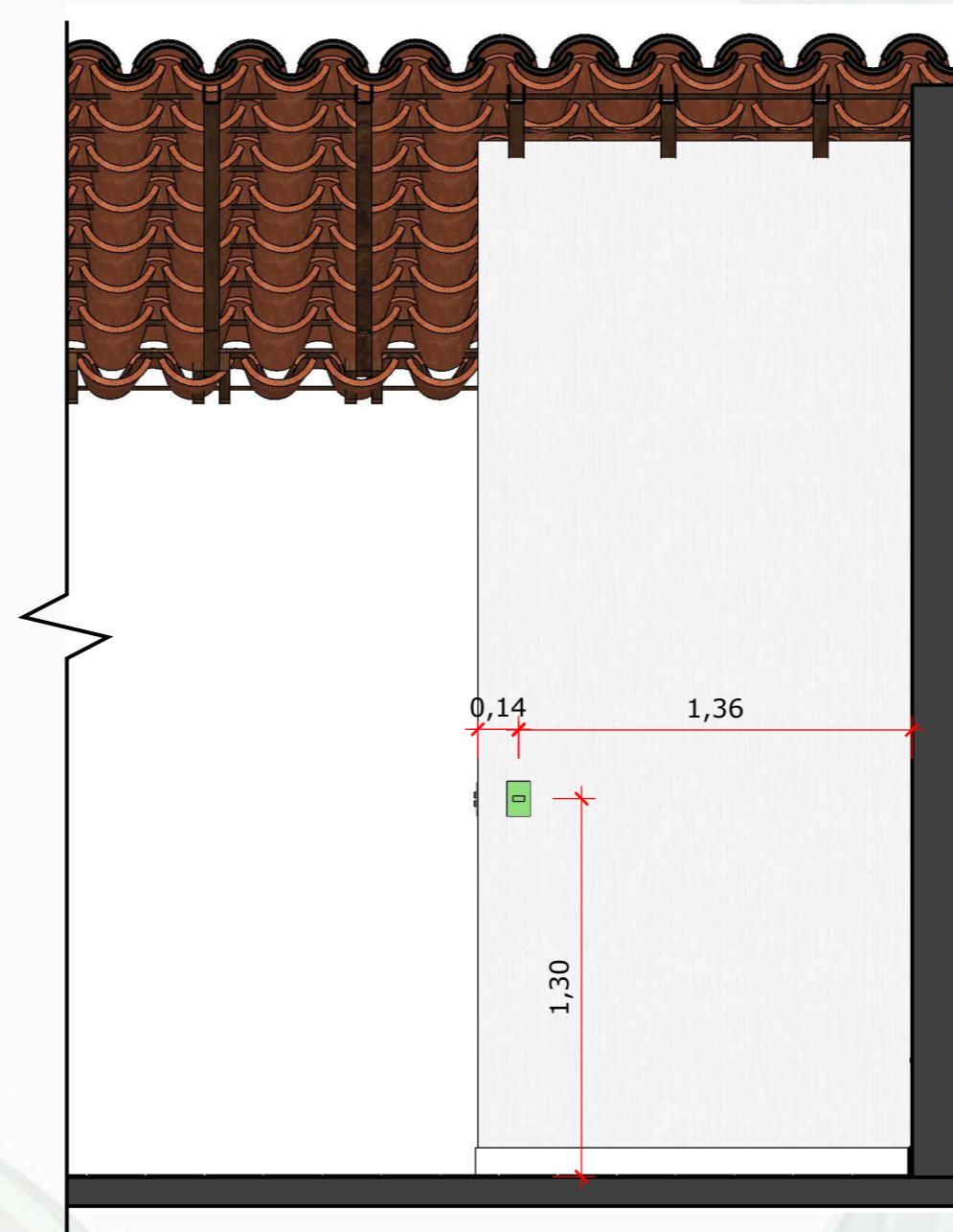

VISTA PONTOS TÉCNICOS - E
ESCALA 1.:25

Legenda:

 Interruptor 1 módulo nova



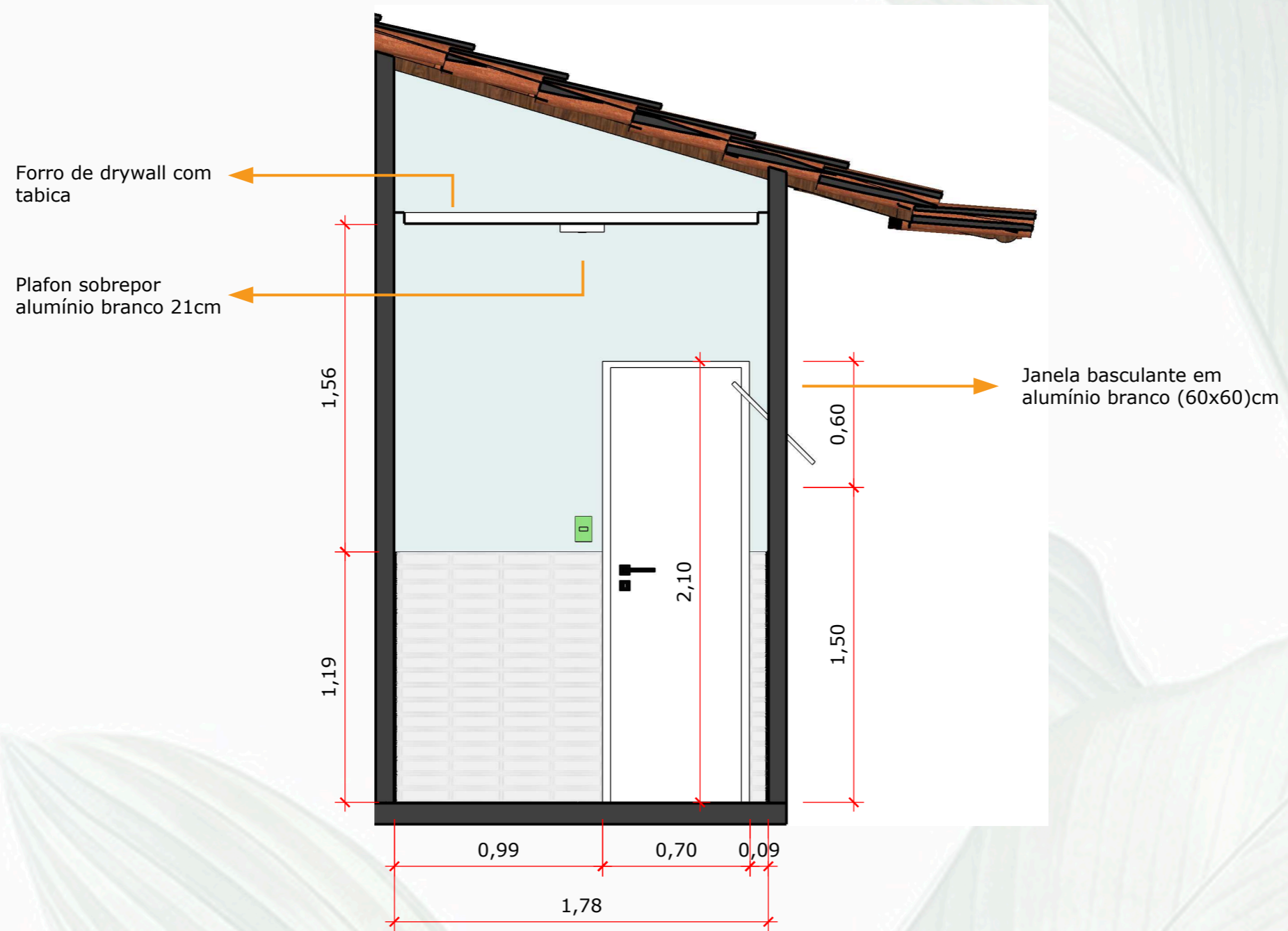

VISTA GERAL - F
 ESCALA 1.:25

Legenda:

-  Interruptor 1 módulo nova

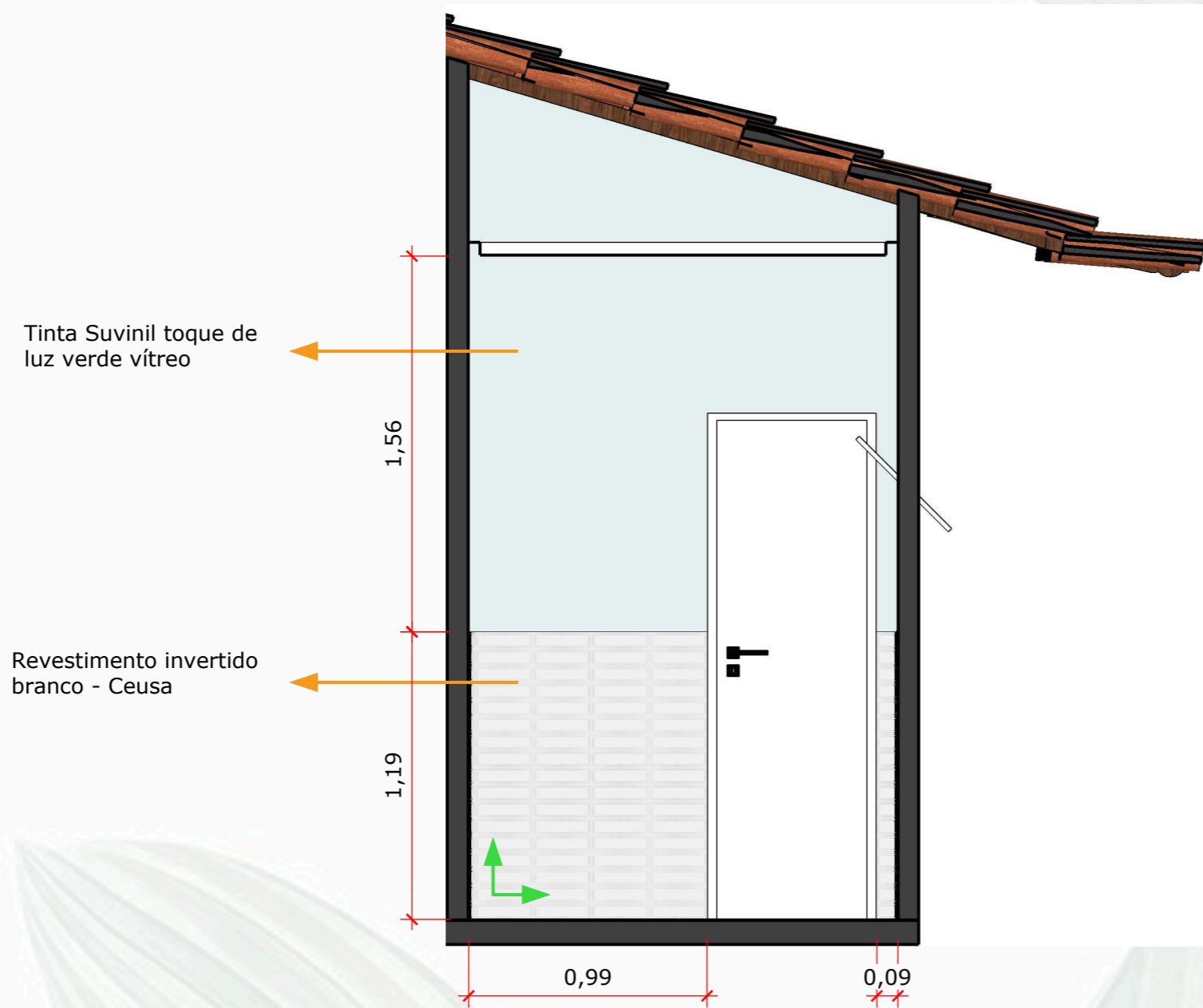

VISTA REVESTIMENTOS - F
 ESCALA 1.:25

Legenda:

 Início da paginação

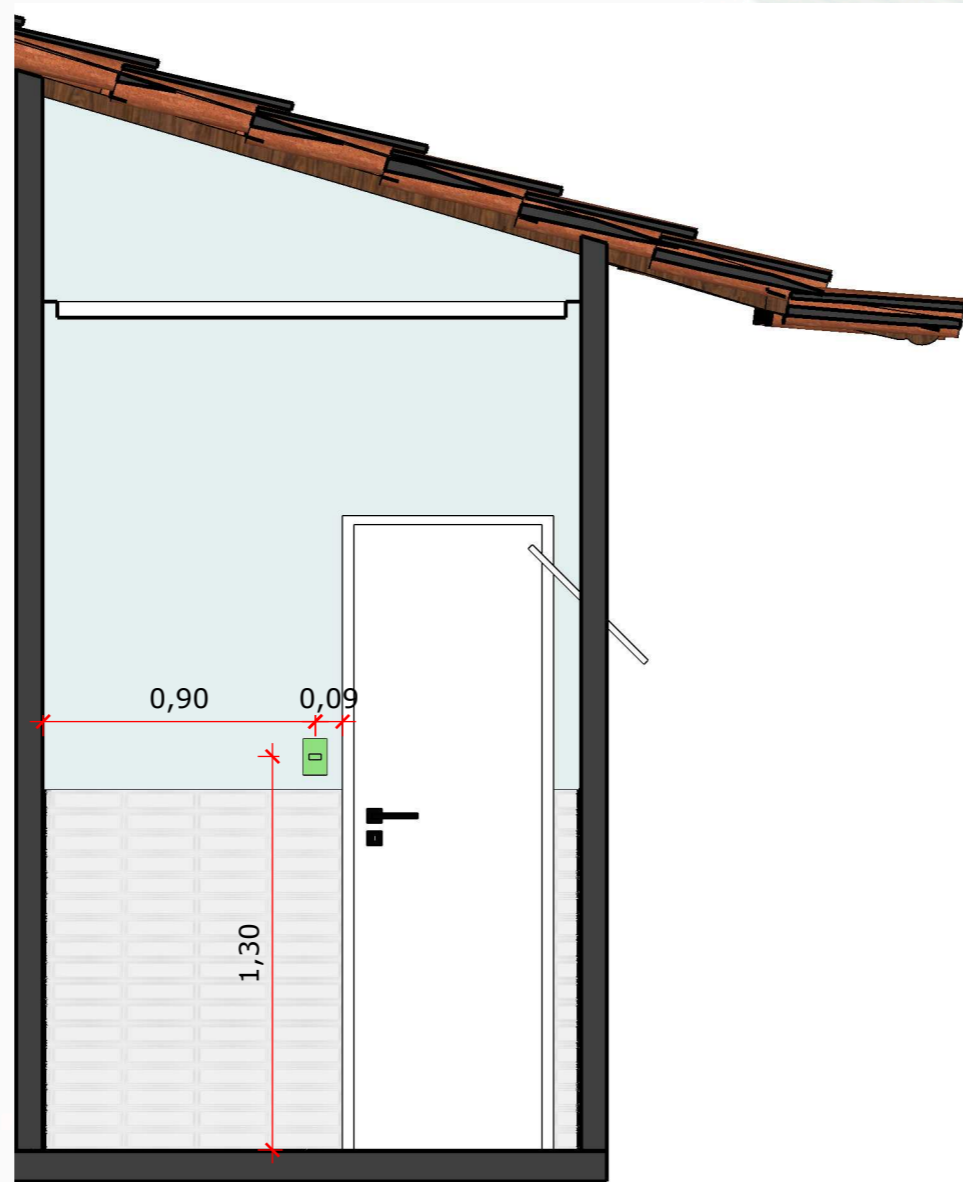

VISTA PONTOS TÉCNICOS - F
ESCALA 1.:25

Legenda:

 Interruptor 1 módulo nova

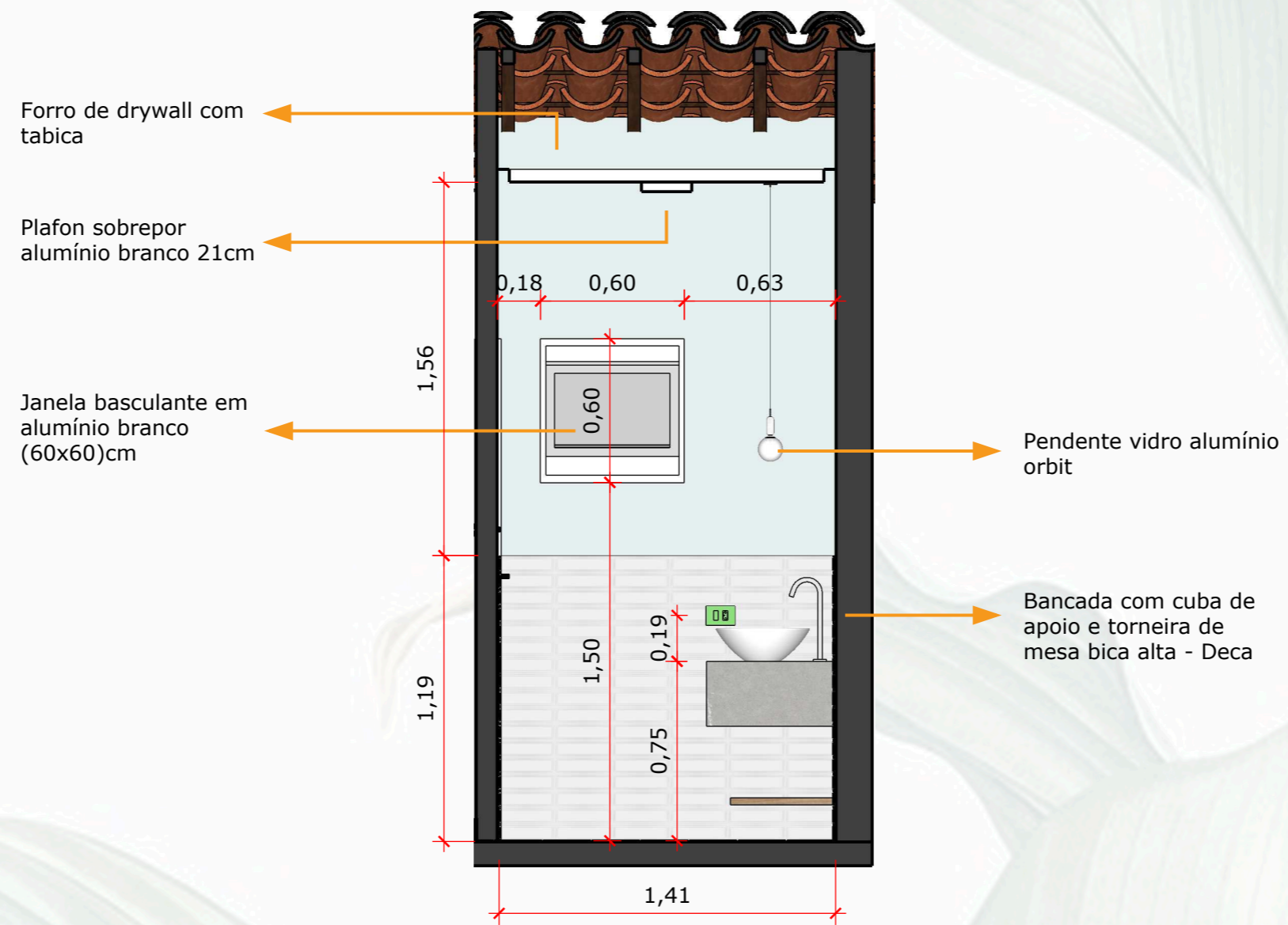

VISTA GERAL - G
 ESCALA 1.:25

Legenda:

 Interruptor 1 módulo + tomada 1 módulo nova

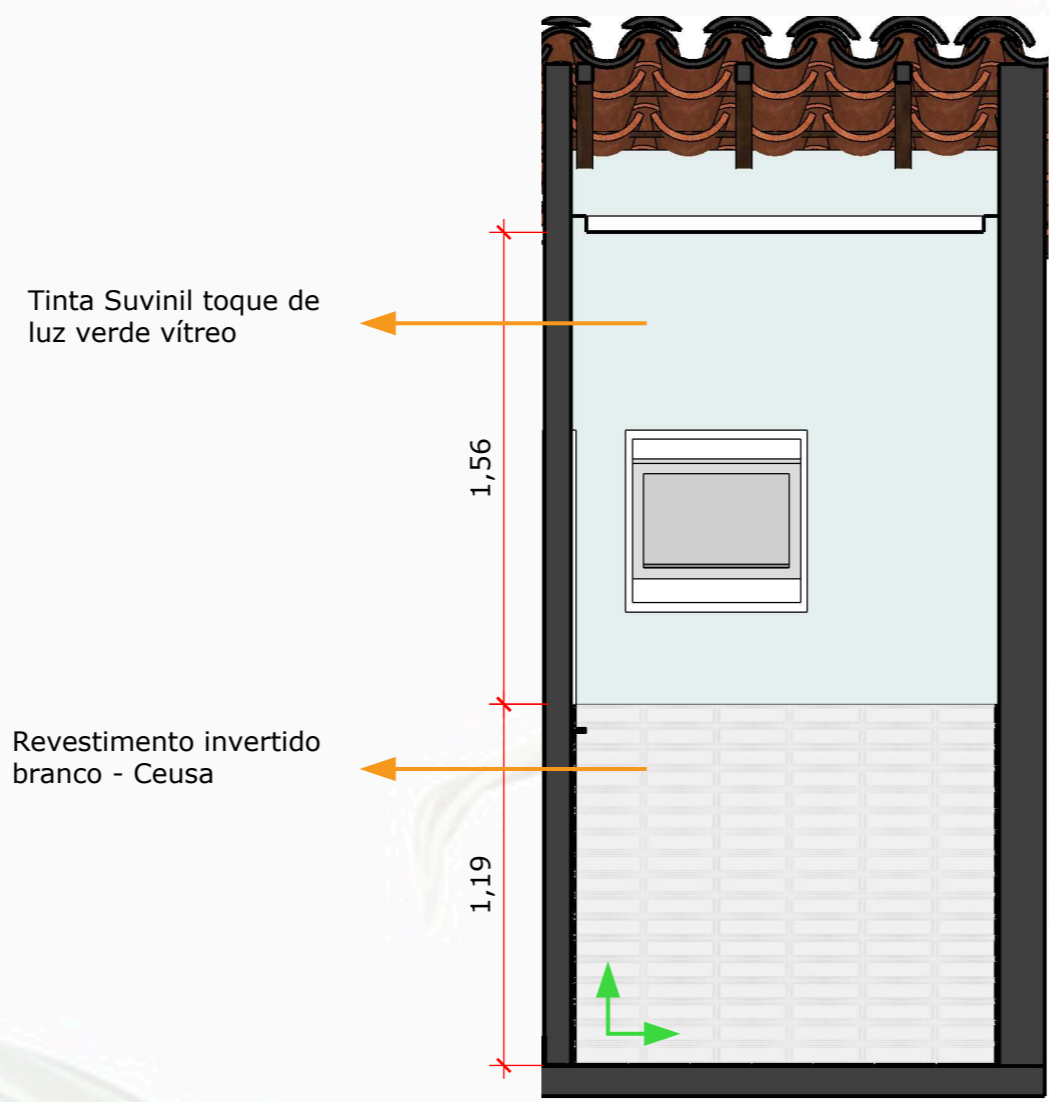

VISTA REVESTIMENTOS - G
ESCALA 1.:25

Legenda:

 Início da paginação

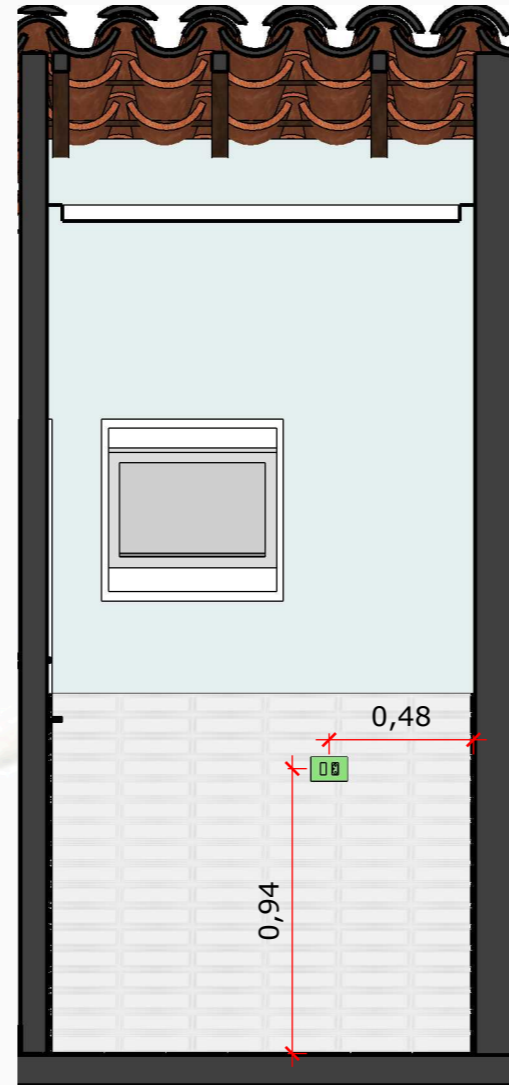

VISTA PONTOS TÉCNICOS - G
ESCALA 1.:25

Legenda:

 Interruptor 1 módulo + tomada 1 módulo nova

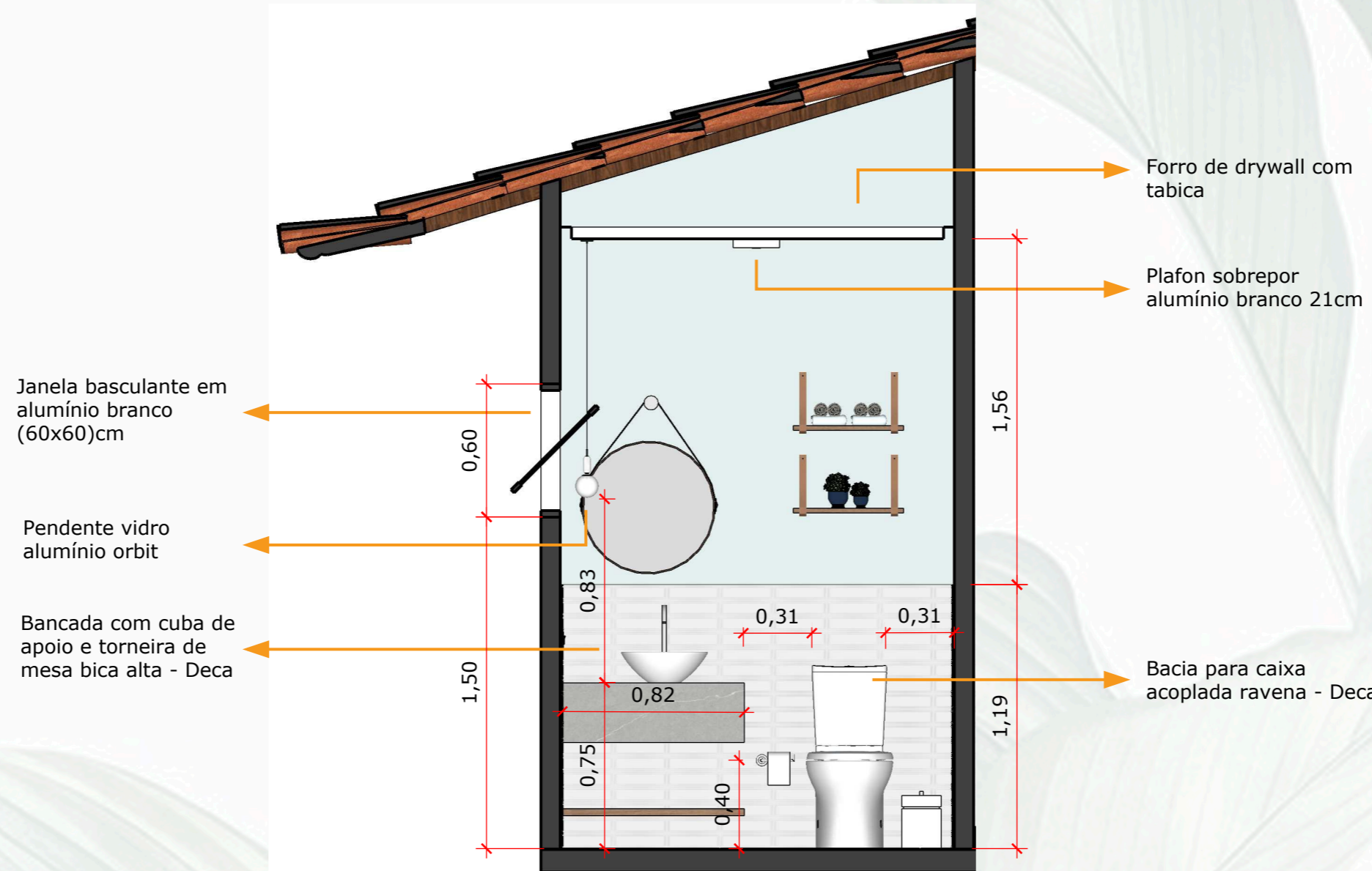

VISTA GERAL - H
 ESCALA 1.:25

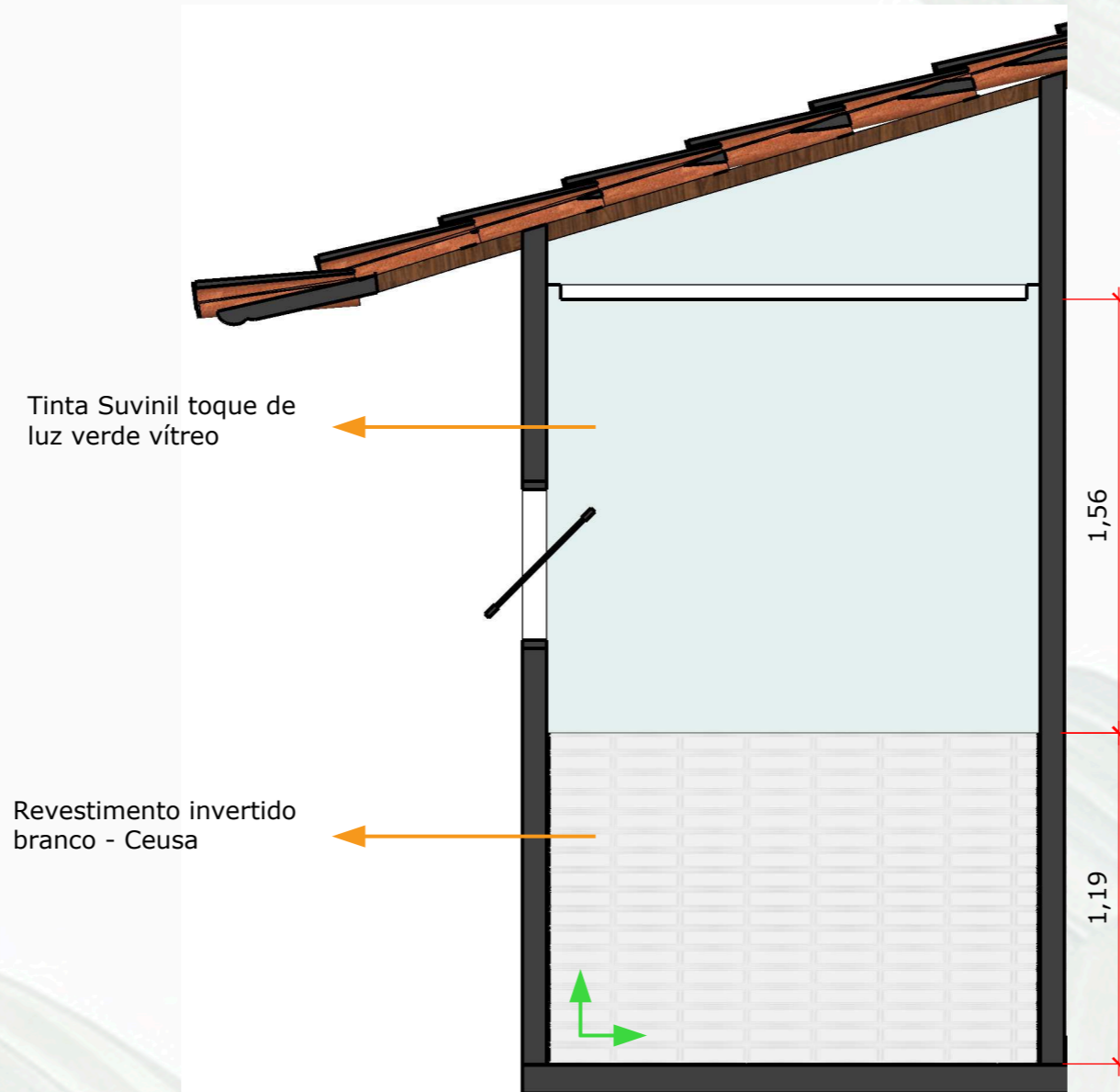

VISTA REVESTIMENTOS - H
ESCALA 1.:25

Legenda:

 Início da paginação

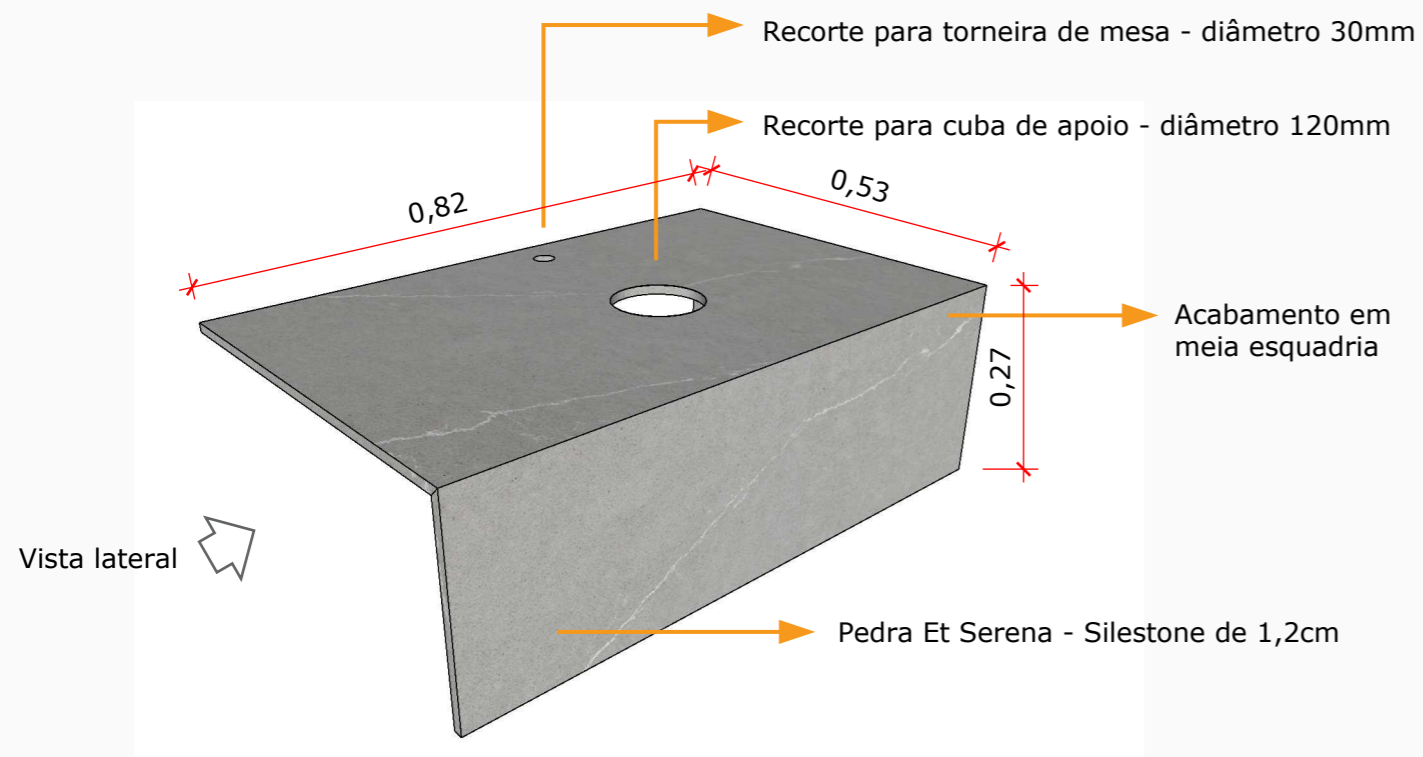

PERSPECTIVA BANCADA LAVABO
SEM ESCALA



VISTA FRONTAL BANCADA LAVABO
ESCALA 1.:10

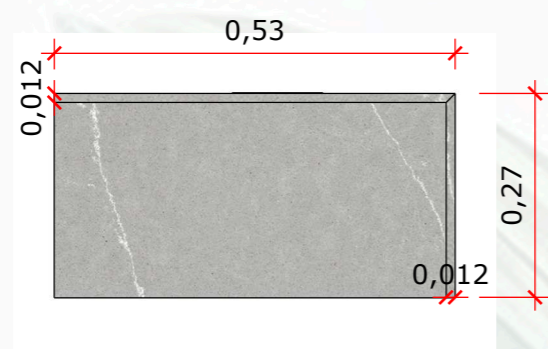

VISTA LATERAL ESQUERDA BANCADA LAVABO
ESCALA 1.:10

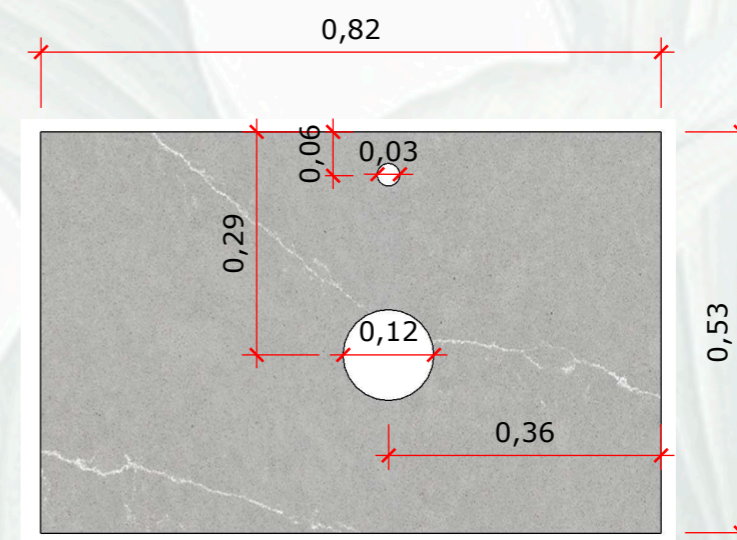

VISTA SUPERIOR BANCADA LAVABO
ESCALA 1.:10

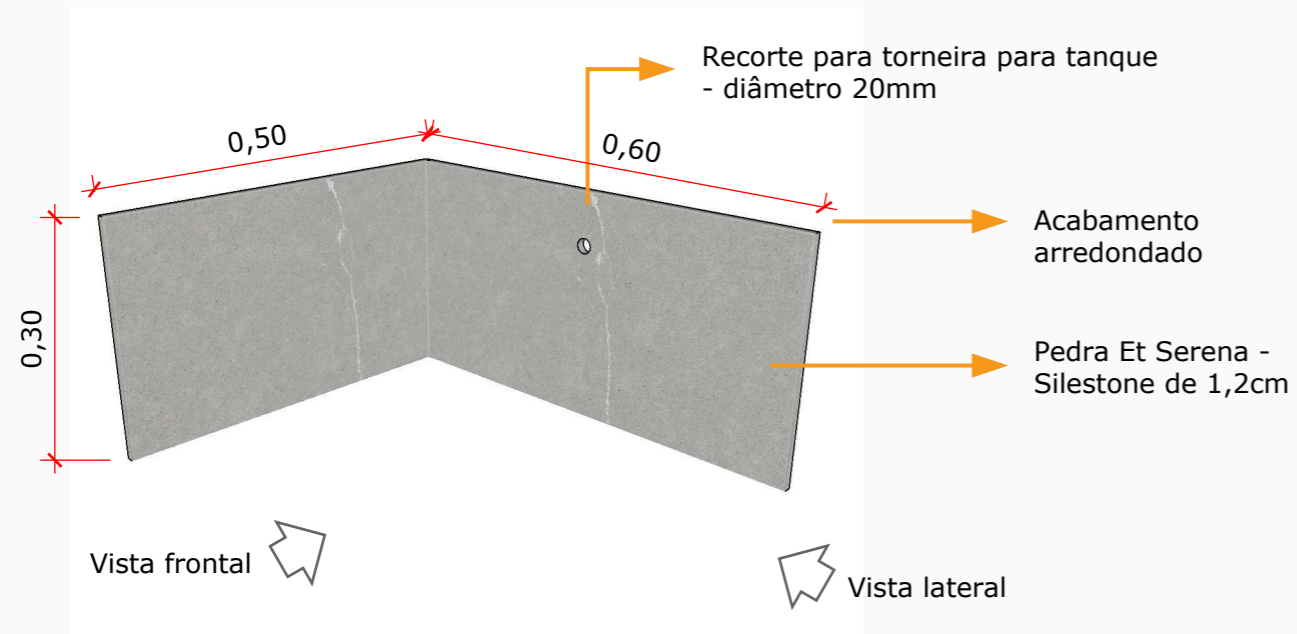

PERSPECTIVA FRONTÃO TANQUE
SEM ESCALA

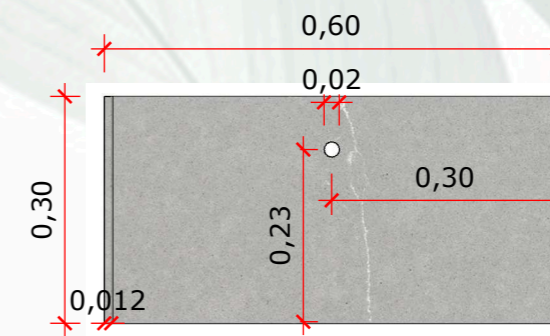

VISTA FRONTAL FRONTÃO TANQUE
ESCALA 1.:10

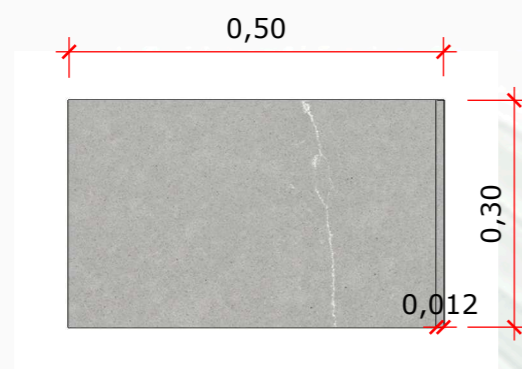

VISTA LATERAL DIREITA FRONTÃO TANQUE
ESCALA 1.:10

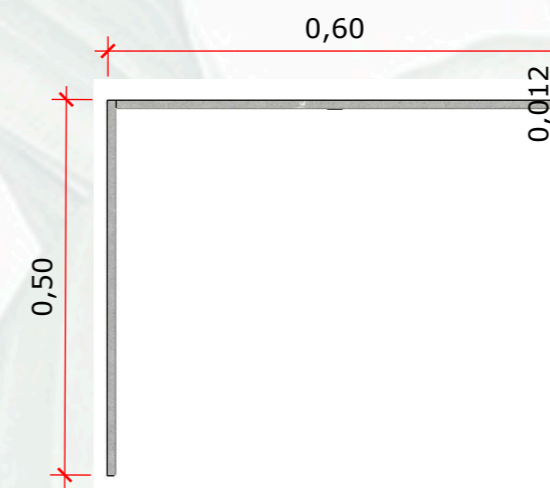

VISTA SUPERIOR FRONTÃO TANQUE
ESCALA 1.:10

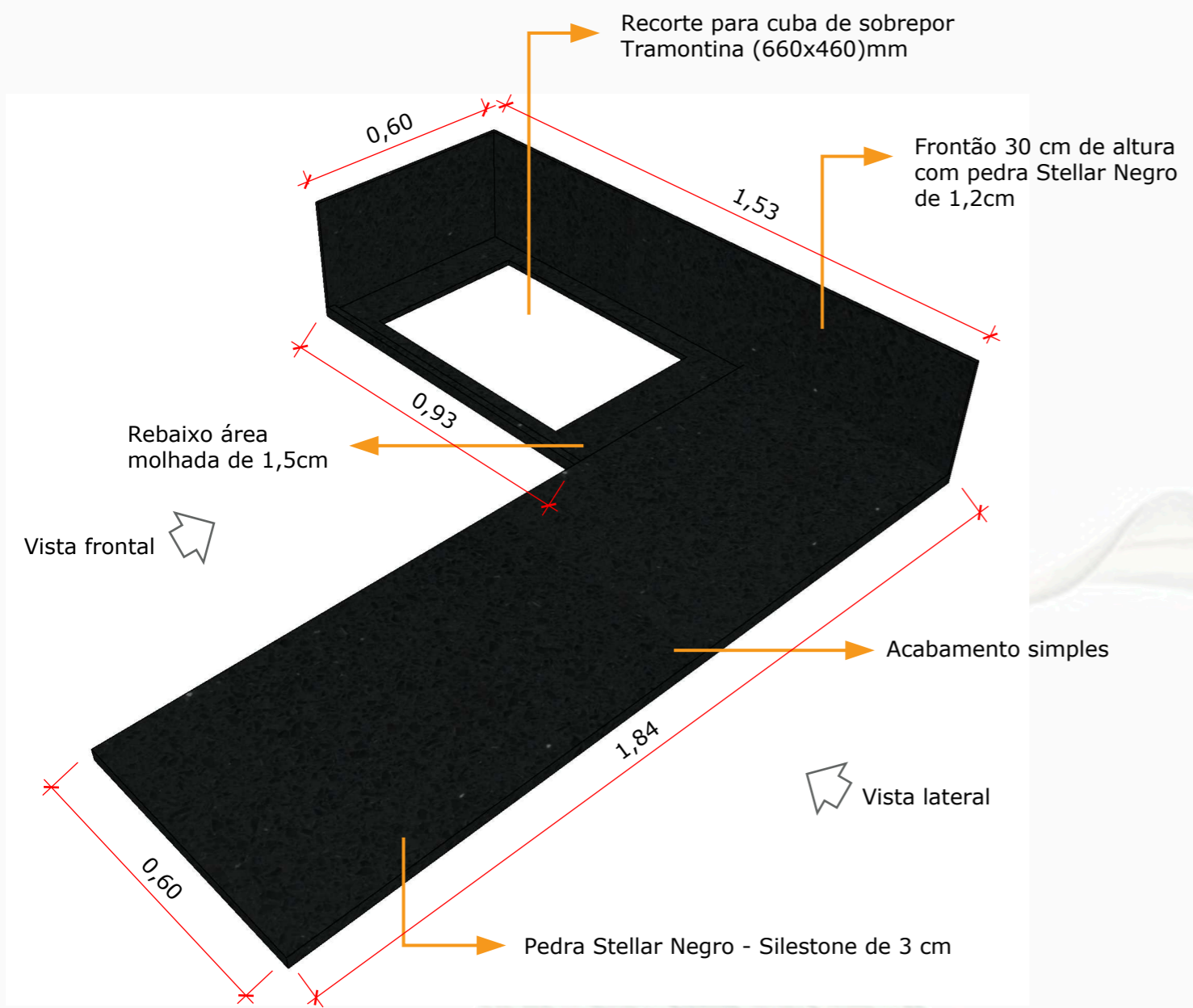

PERSPECTIVA BANCADA/FRONTÃO
SEM ESCALA

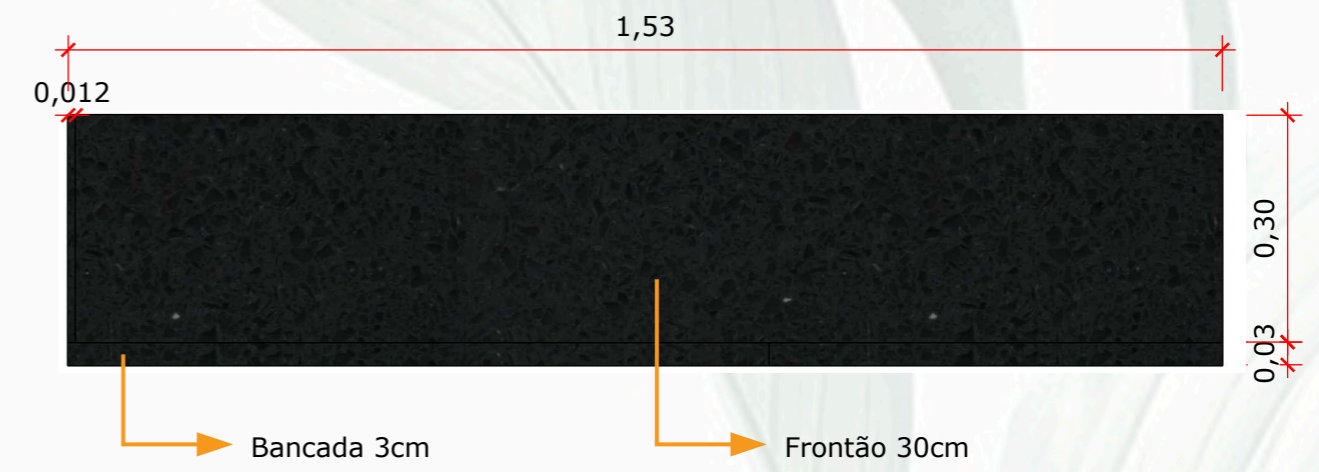

VISTA FRONTAL BANCADA/FRONTÃO
ESCALA 1.:10

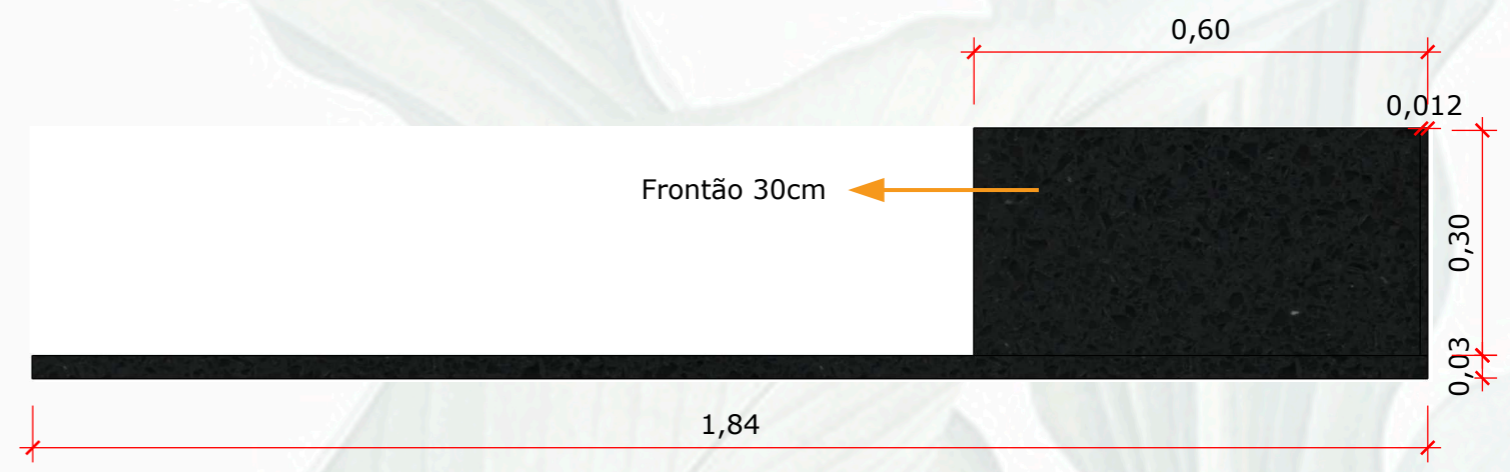

VISTA LATERAL DIREITA BANCADA/FRONTÃO
ESCALA 1.:10

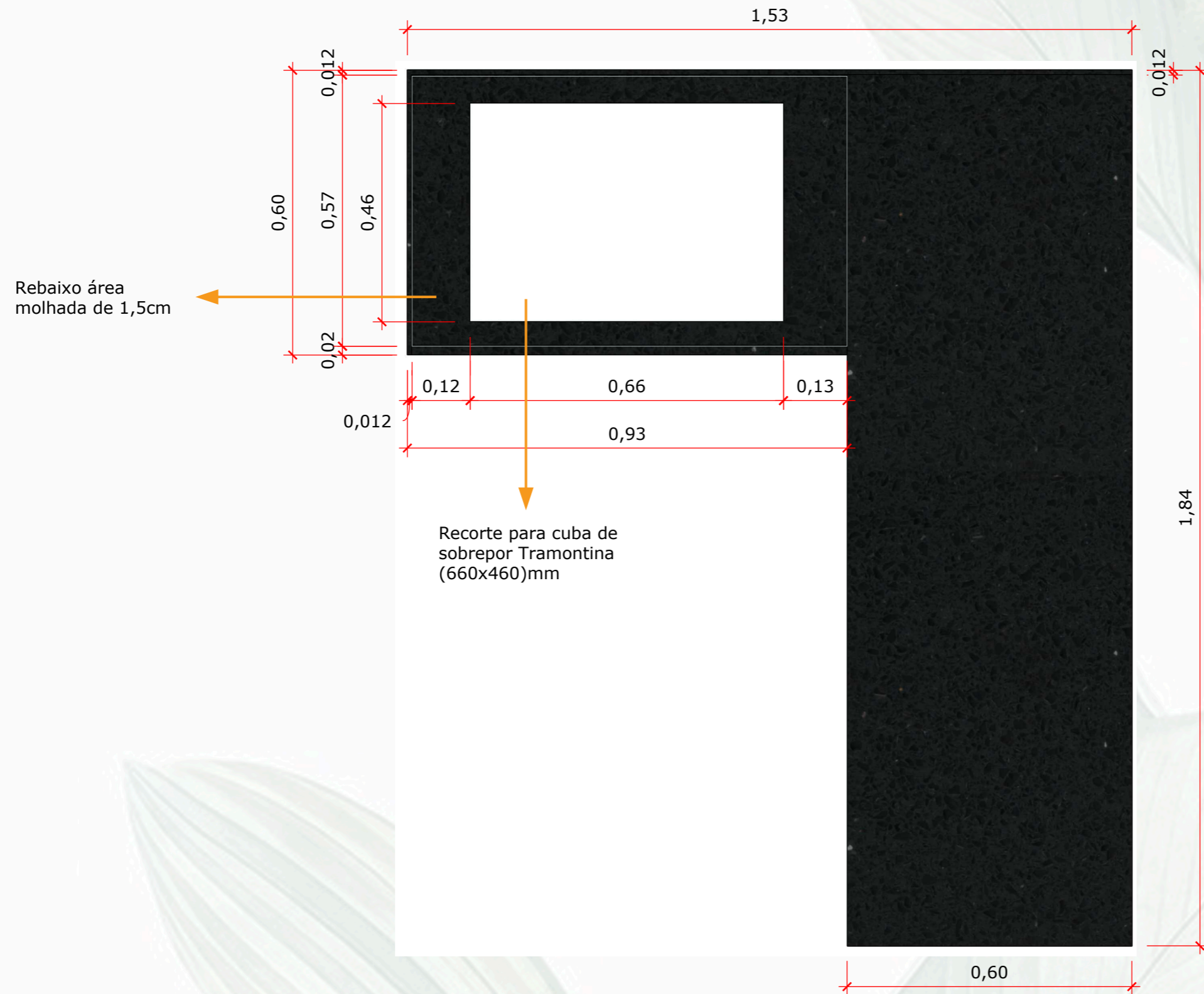

VISTA SUPERIOR BANCADA/FRONTÃO
 ESCALA 1.:10

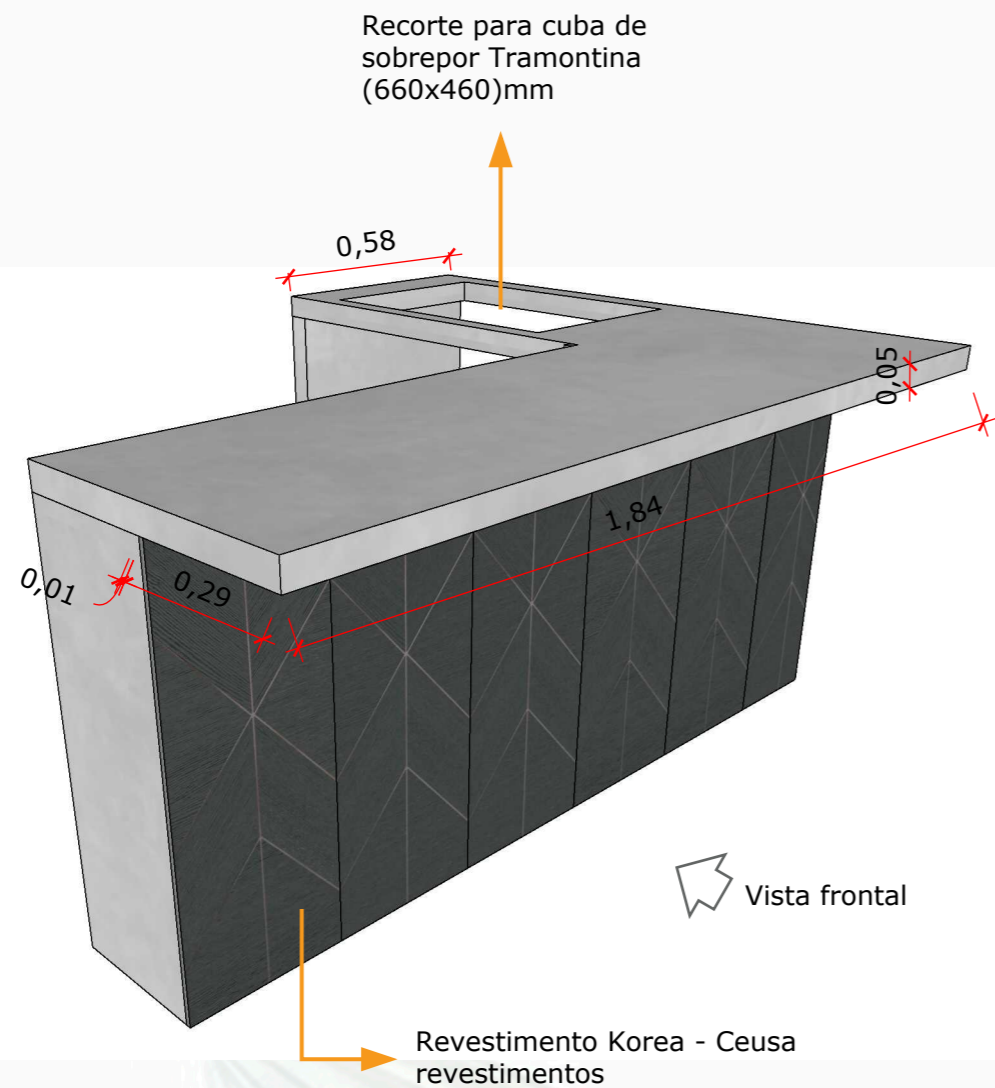

PERSPECTIVA FRONTAL BANCADA ALVENARIA
SEM ESCALA

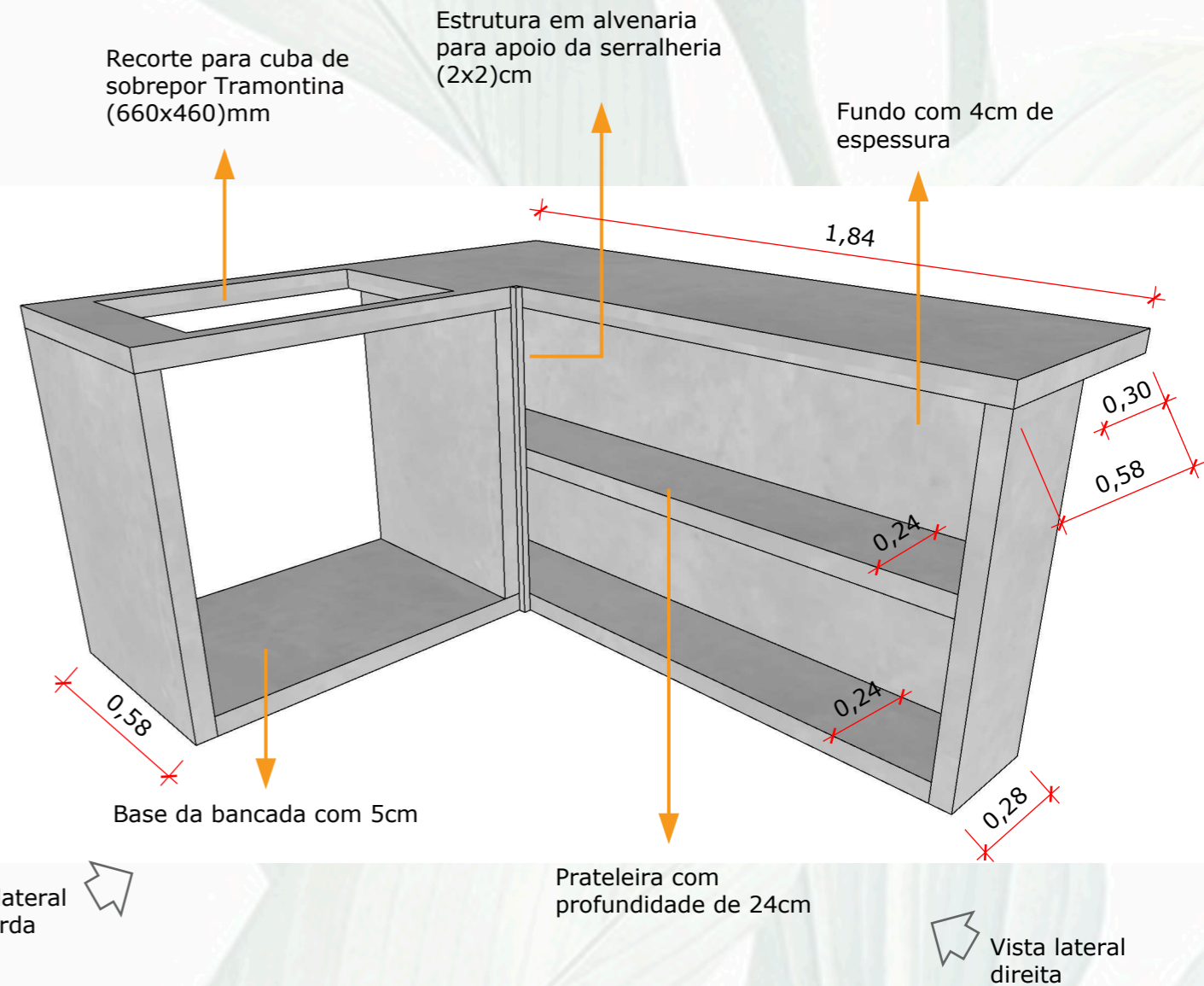

PERSPECTIVA INTERNA BANCADA ALVENARIA
SEM ESCALA

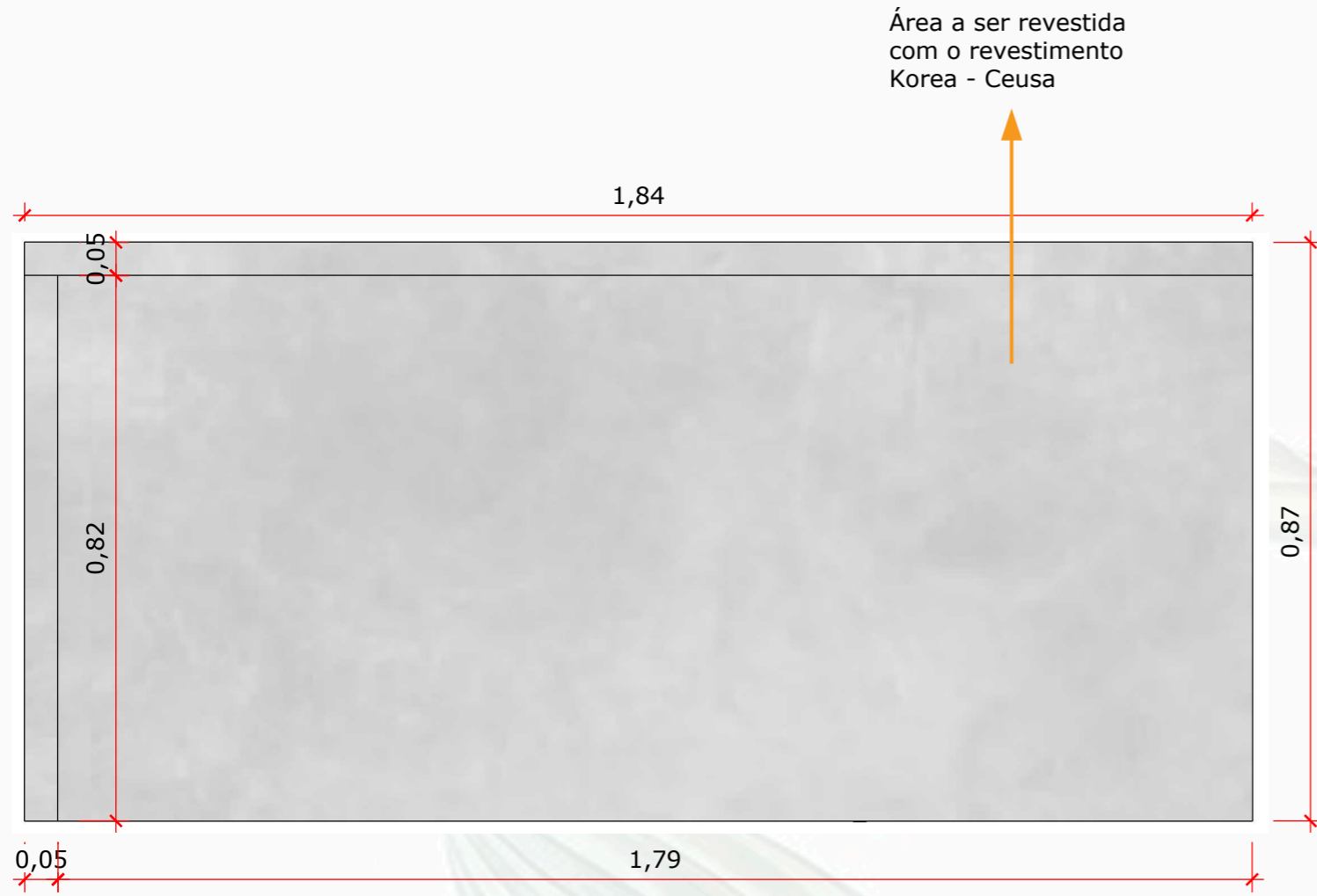

VISTA FRONTAL BANCADA ALVENARIA
ESCALA 1.:10

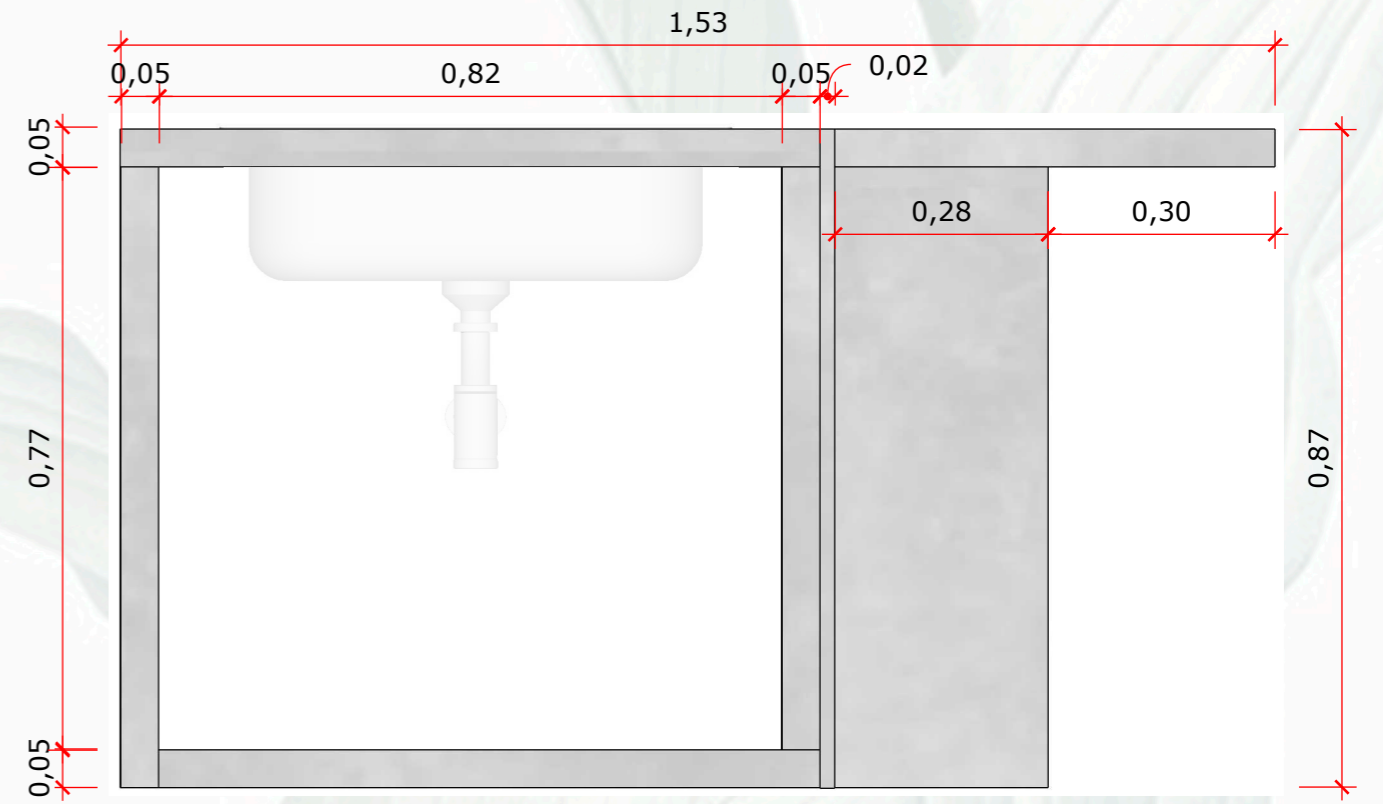

VISTA LATERAL DIREITA BANCADA ALVENARIA
ESCALA 1.:10

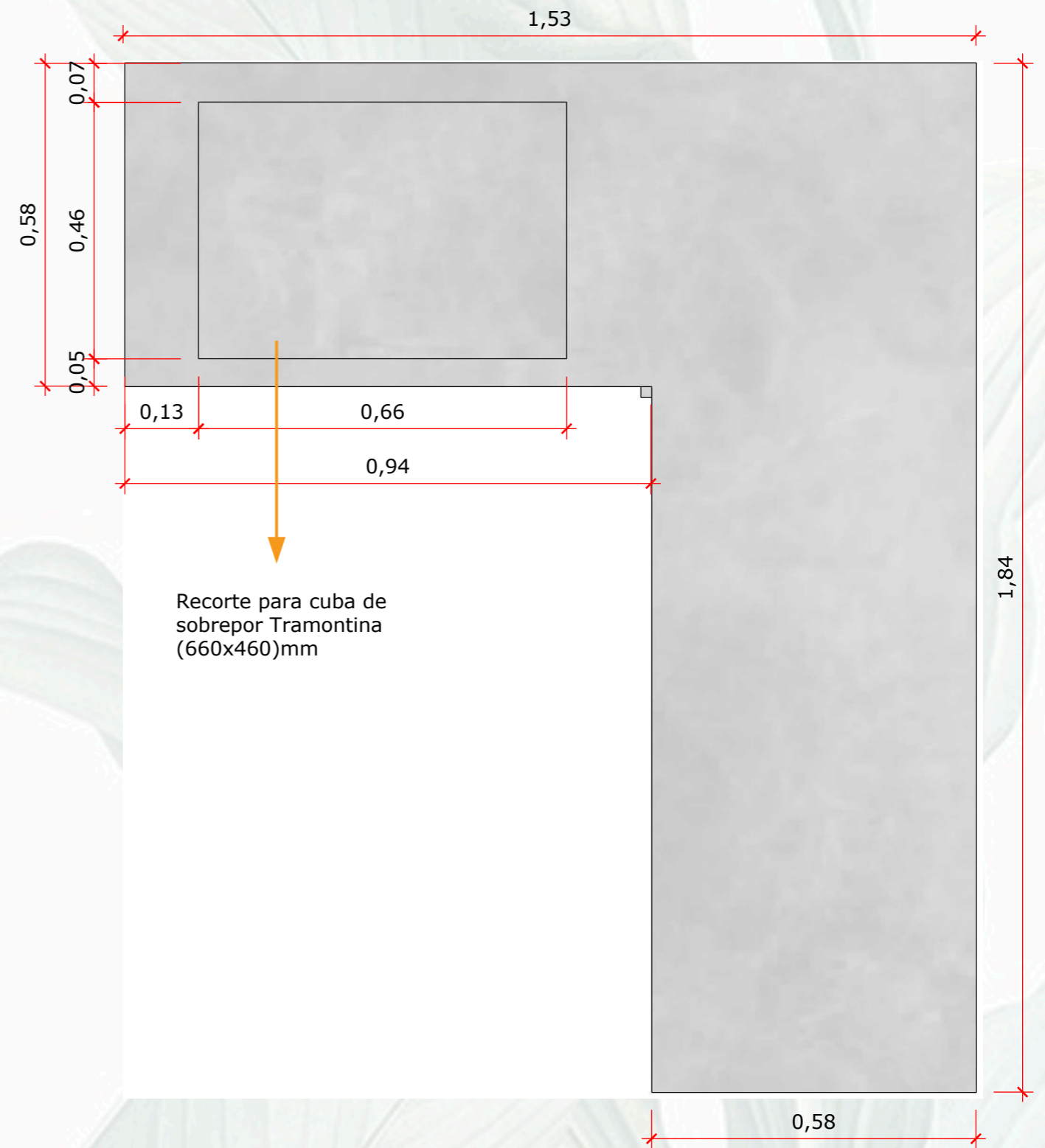
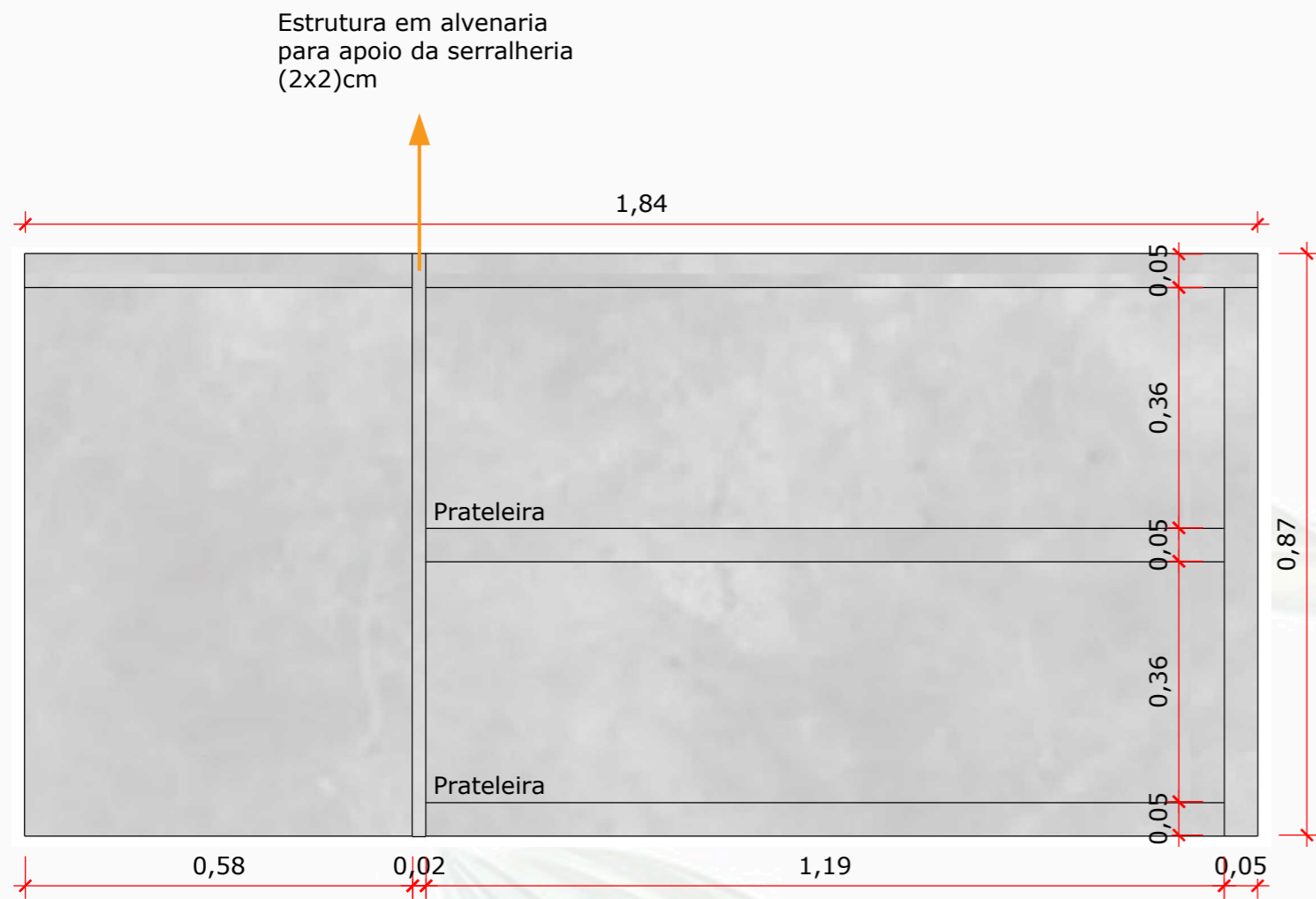

VISTA LATERAL ESQUERDA BANCADA ALVENARIA
 ESCALA 1.:10

VISTA SUPERIOR BANCADA ALVENARIA
 ESCALA 1.:10

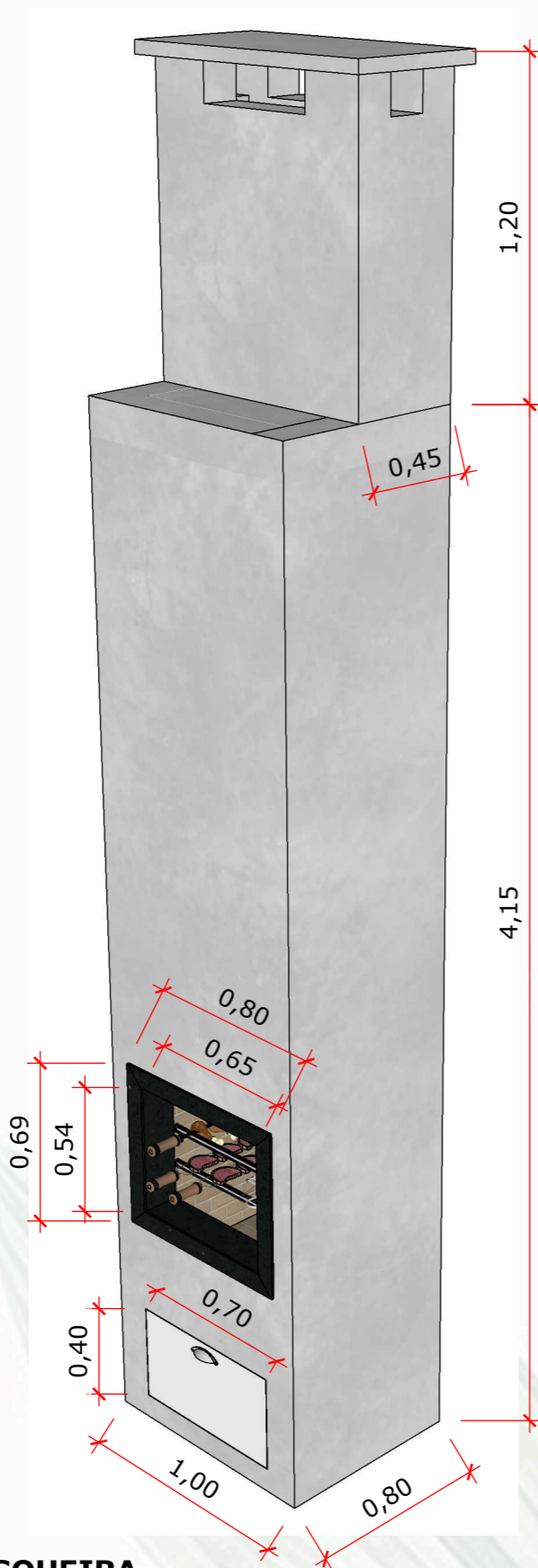

PERSPECTIVA CHURRASQUEIRA
SEM ESCALA

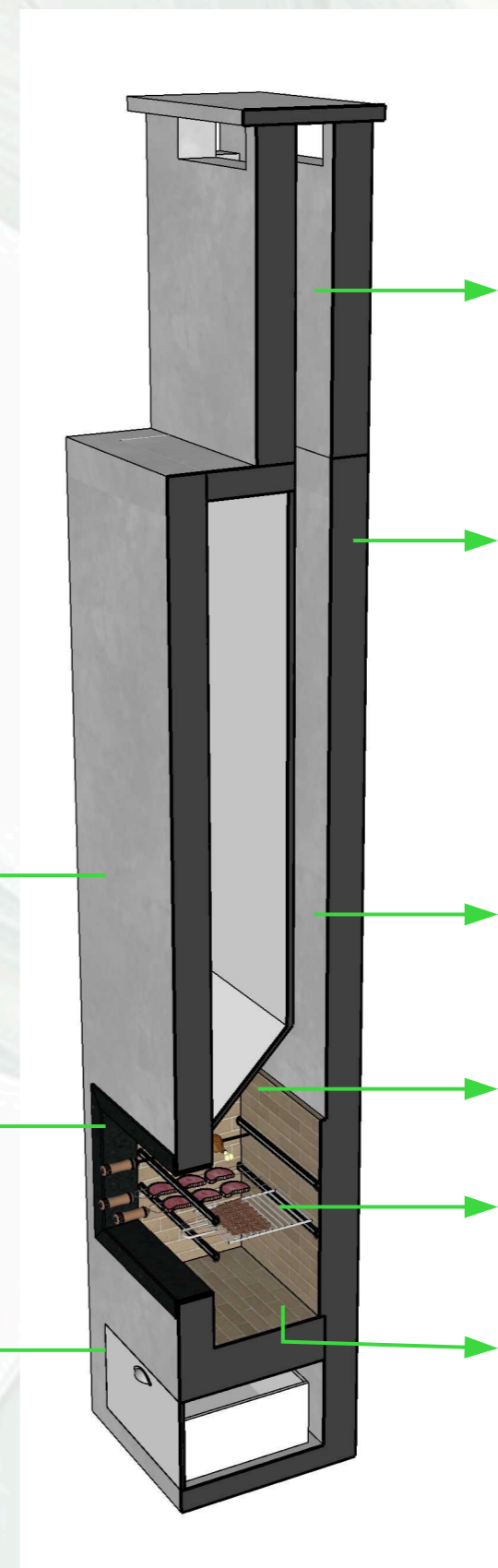

PERSPECTIVA EM CORTE CHURRASQUEIRA
SEM ESCALA

Revestimento em Tinta Suvinil cimento queimado dia de chuva

Soleira em pedra Stellar Negro - Silestone - ver det.

Gaveta de correr alumínio branco para carvão/ lenha Dimensão: 40(a)x70(c)x65(l)cm

Altura mínima do telhado a chaminé de 1,00m

Churrasqueira em alvenaria 15cm

Duto para ventilação da churrasqueira com 15cm de largura

Coifa em tijolo refratário ou aço - a definir

Suporte giragrill inox regulável p/ pré moldados 5 espetos

Tijolo refratário 2,5cm de espessura Dimensão interna: 65(c)x47(l)cm

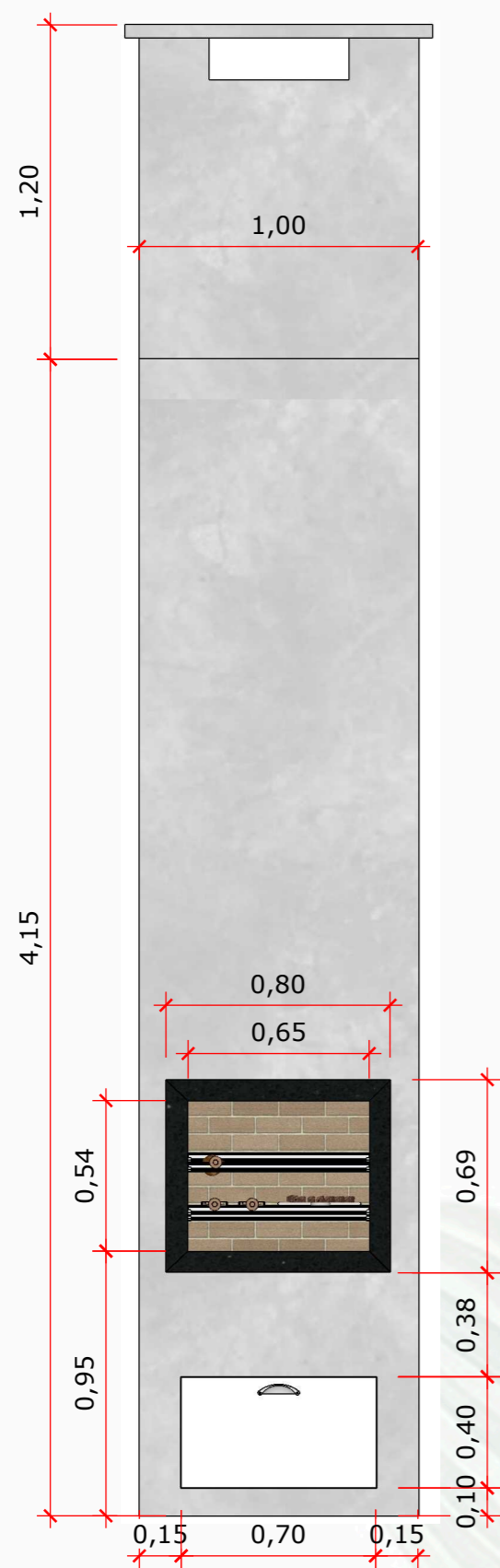

VISTA FRONTAL CHURRASQUEIRA
ESCALA 1.:25

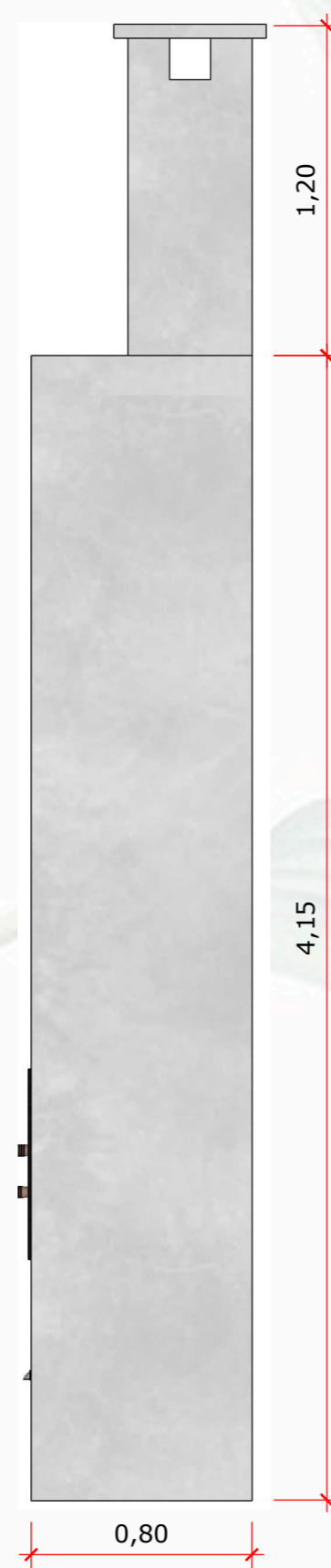

VISTA LATERAL CHURRASQUEIRA
ESCALA 1.:25

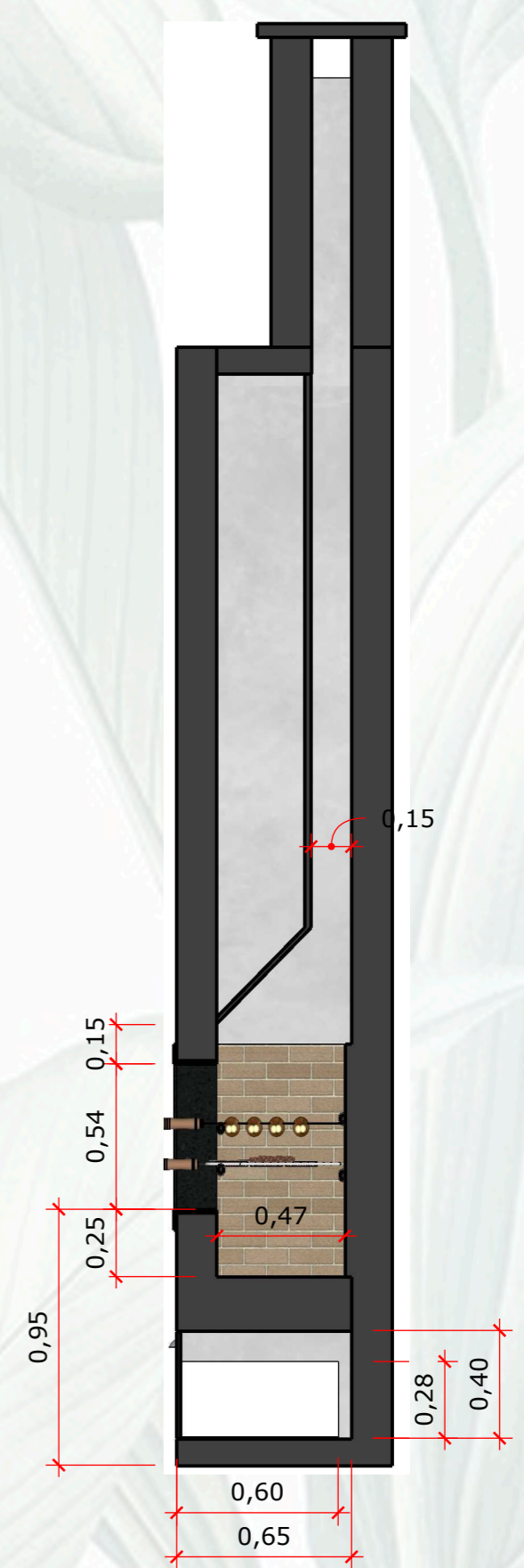

CORTE CHURRASQUEIRA
ESCALA 1.:25

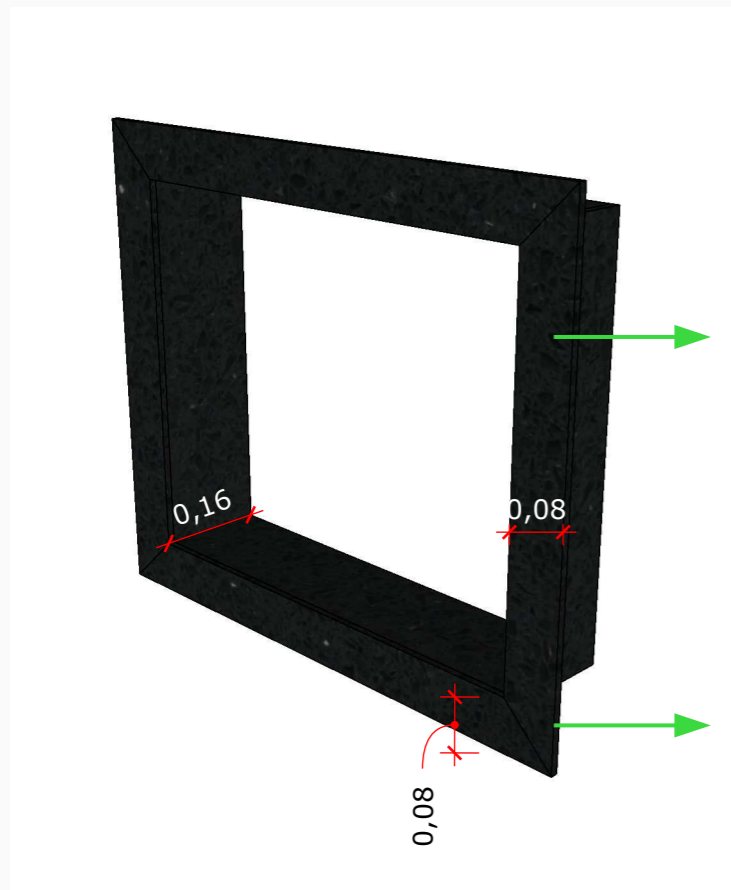

Soleira em pedra Stellas Negro - Silestone de 1,2cm

Acabamento em meia esquadria

PERSPECTIVA SOLEIRA CHURRASQUEIRA
SEM ESCALA

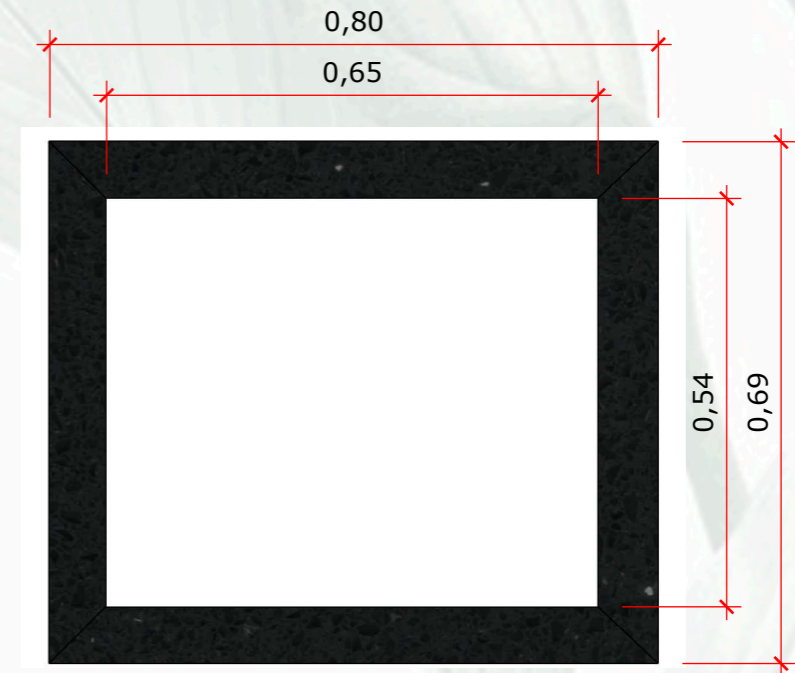

VISTA FRONTAL CHURRASQUEIRA
ESCALA 1.:25

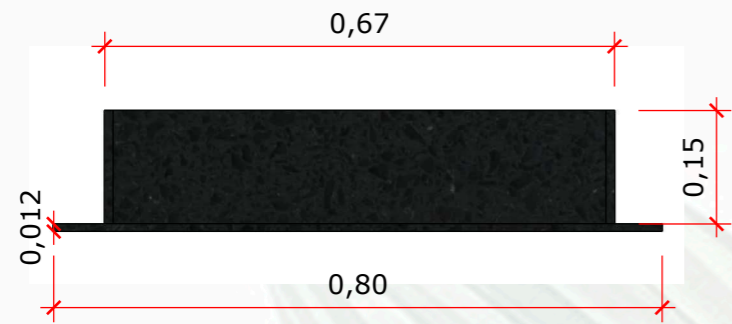

VISTA SUPERIOR CHURRASQUEIRA
ESCALA 1.:25



VISTA LATERAL CHURRASQUEIRA
ESCALA 1.:25