

Portfólio

Mateus Morais de Aguirre

Técnico em eletromecânica.

Estudante de Engenharia de Controle e Automação no Instituto Federal de Goiás, Goiânia.

Fones: (62)3205-2530 / (62)981429683

E-mail: mateusago@gmail.com

Linkedin: <https://br.linkedin.com/in/mateusmoraisdeaguirre>

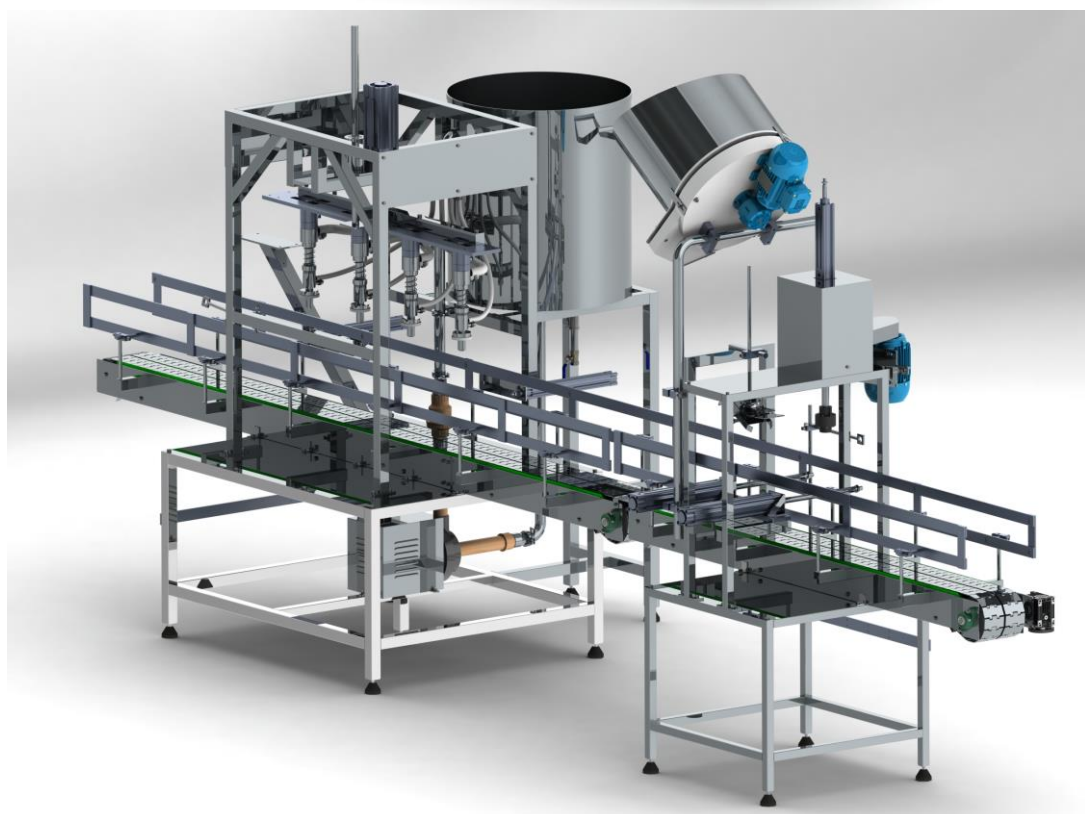

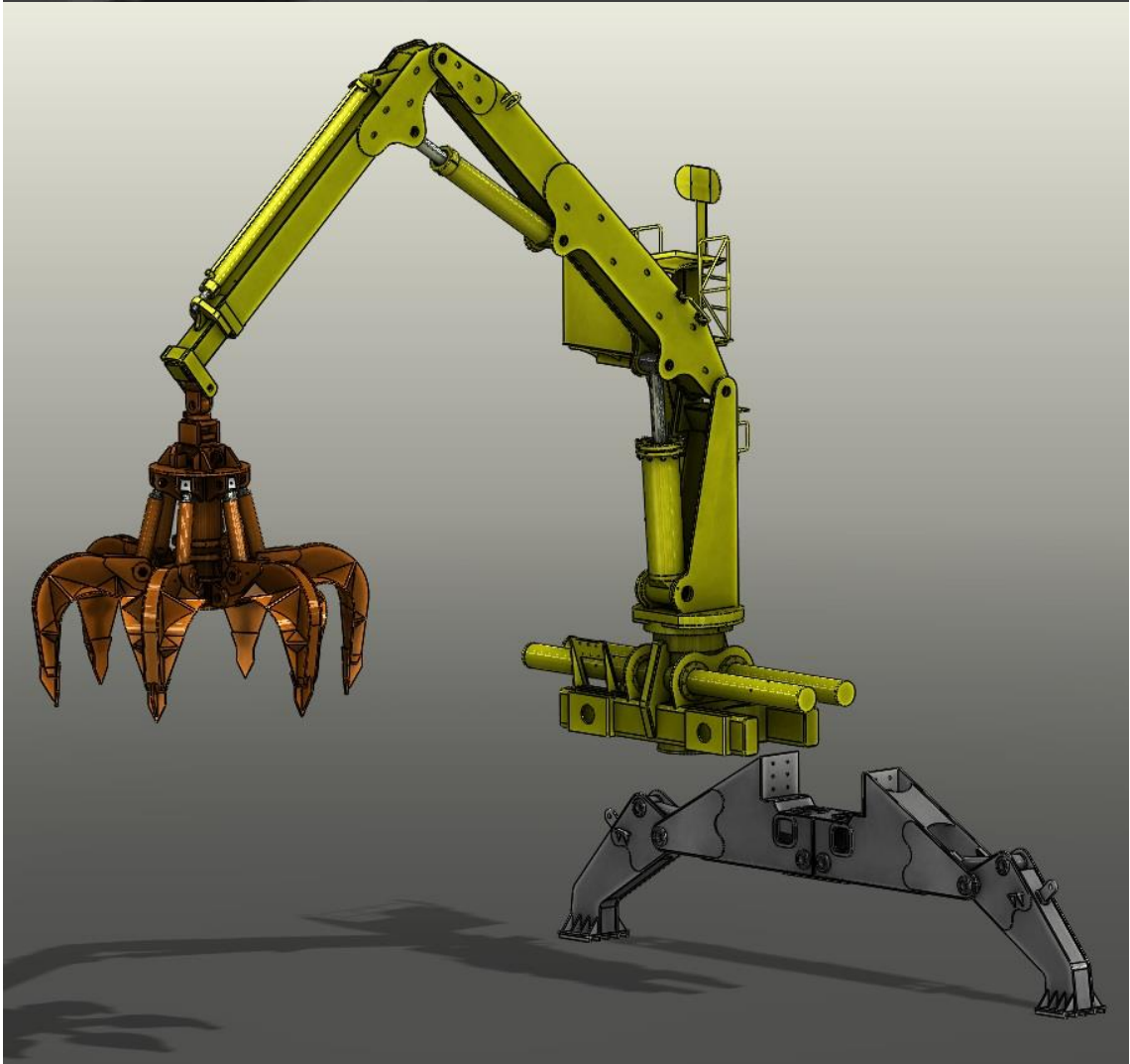
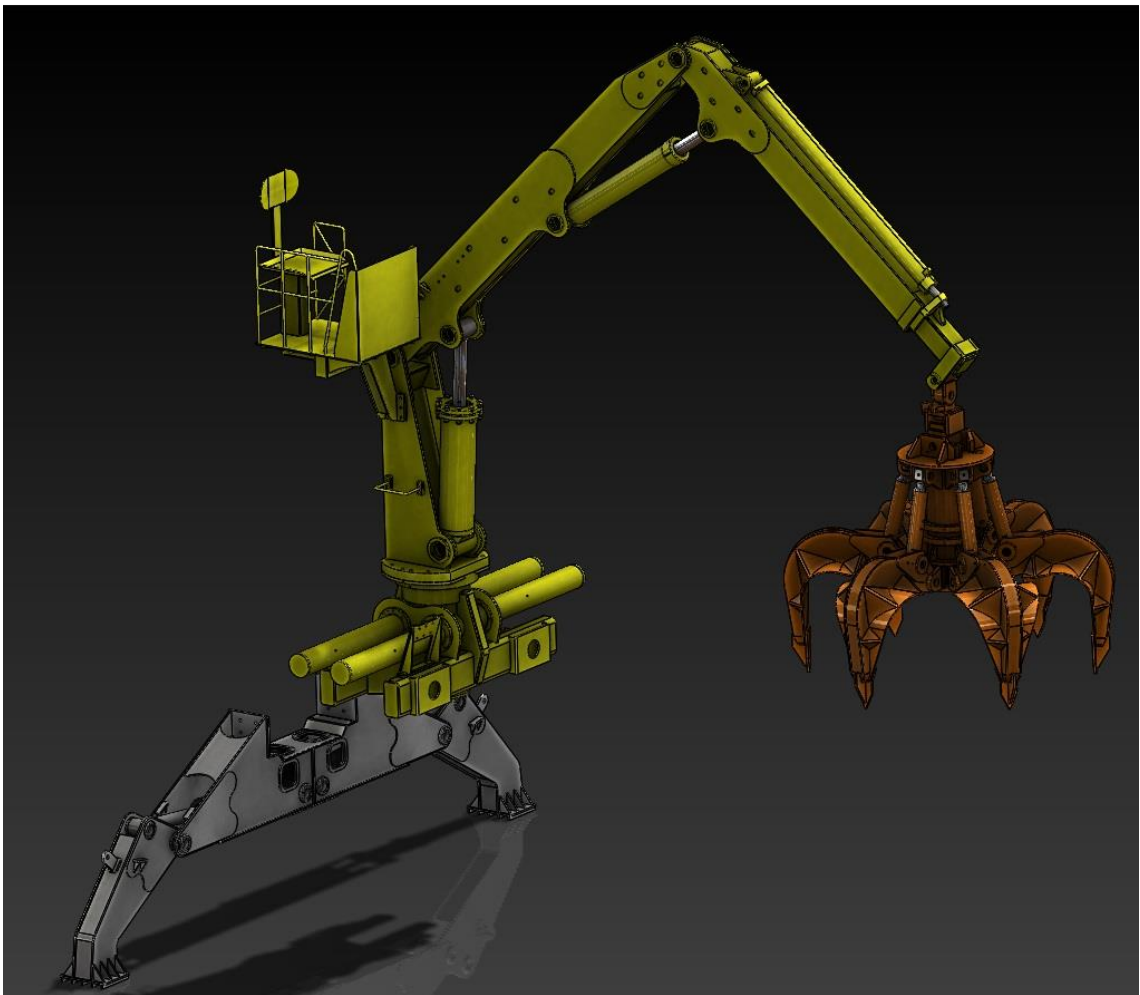

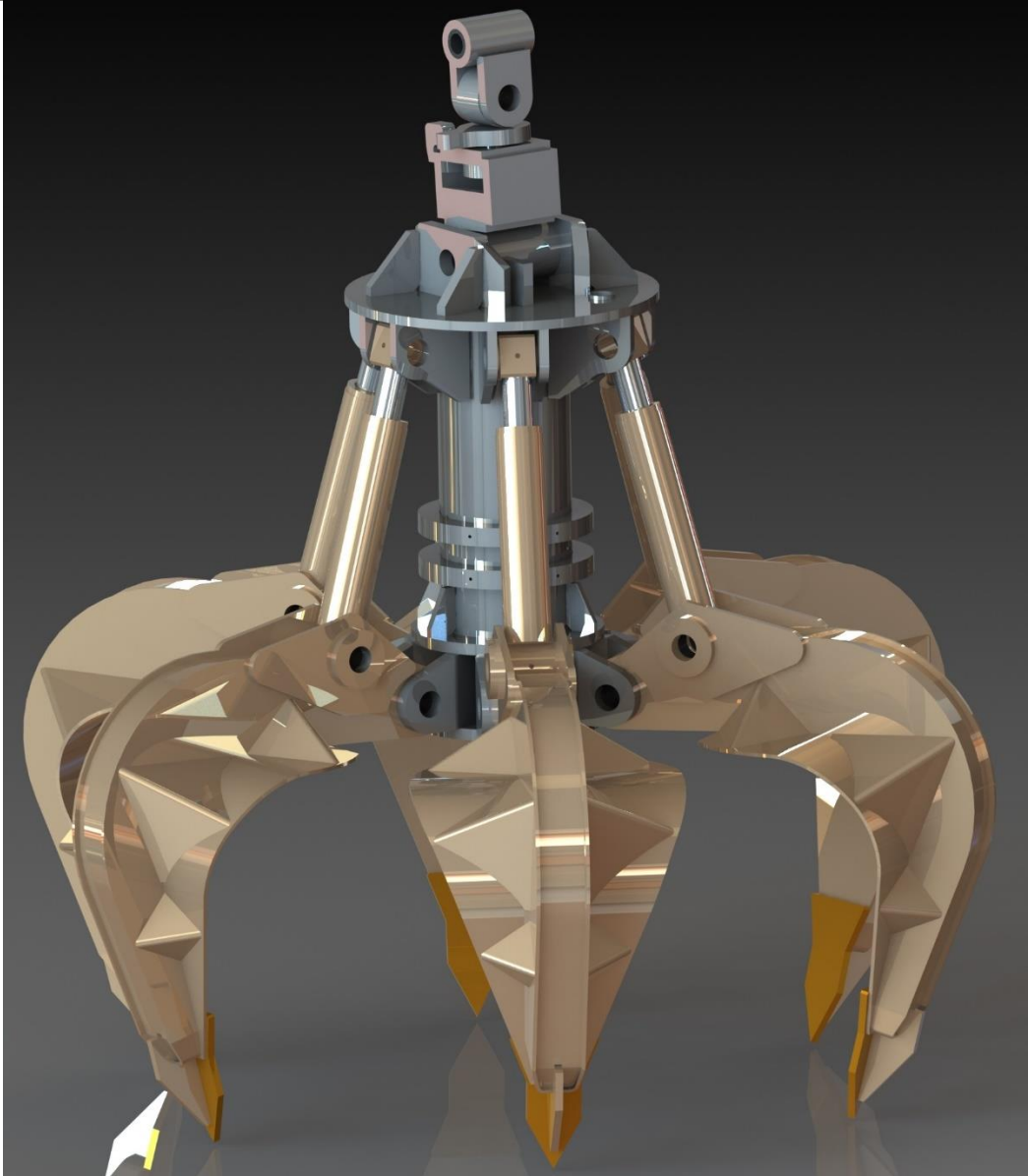

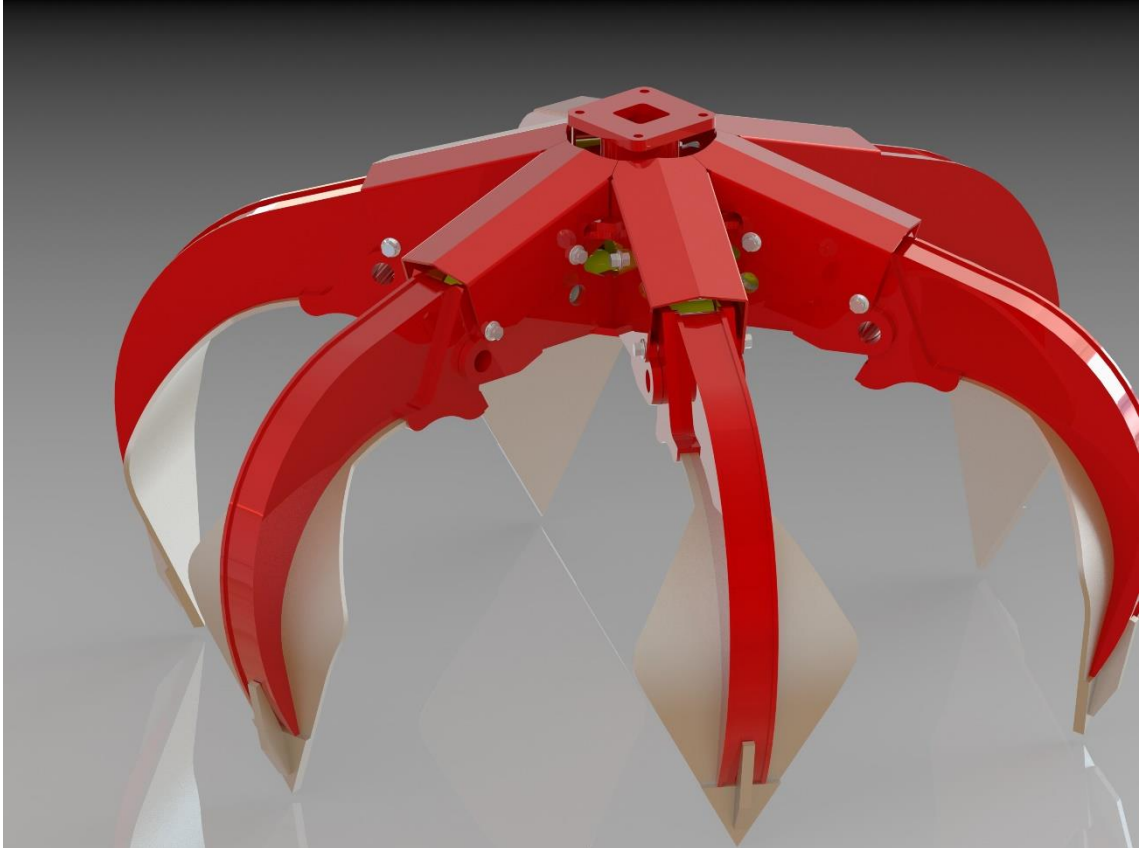

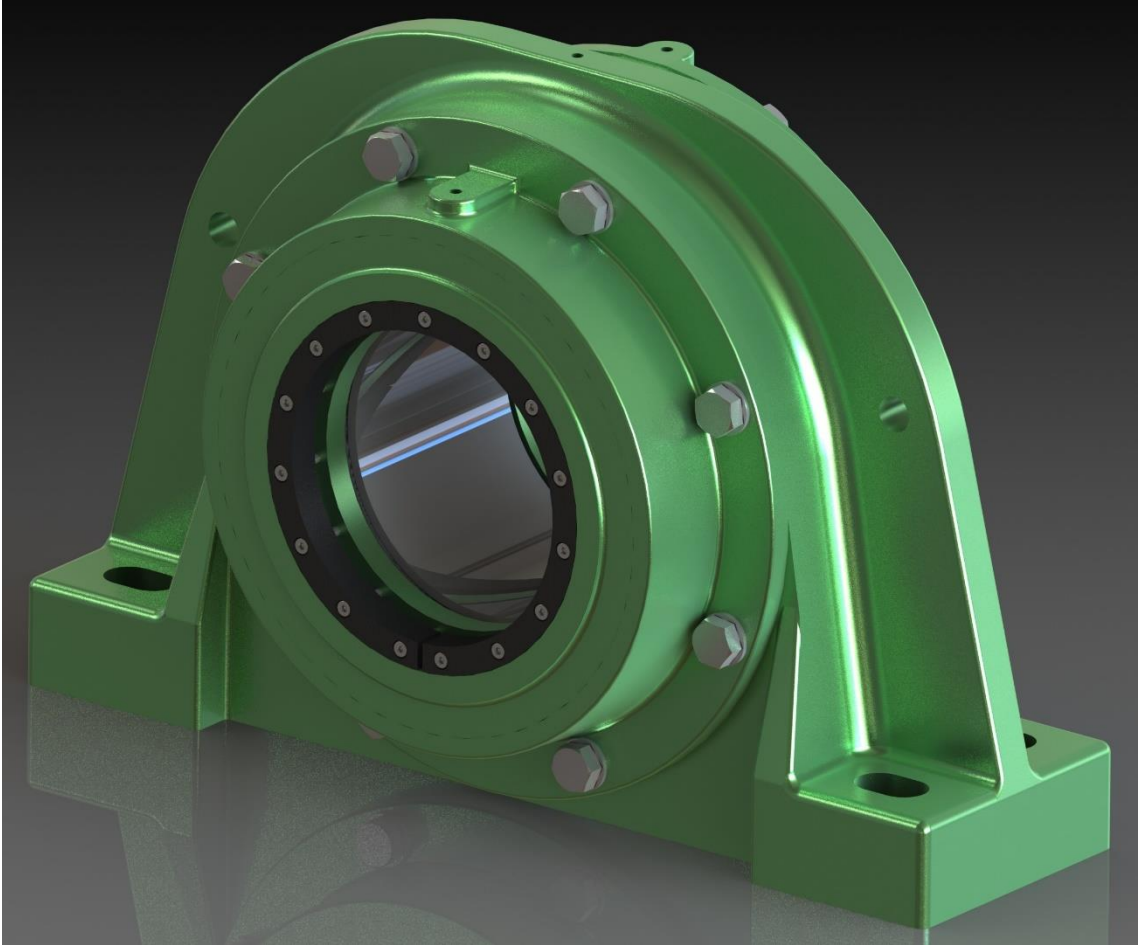
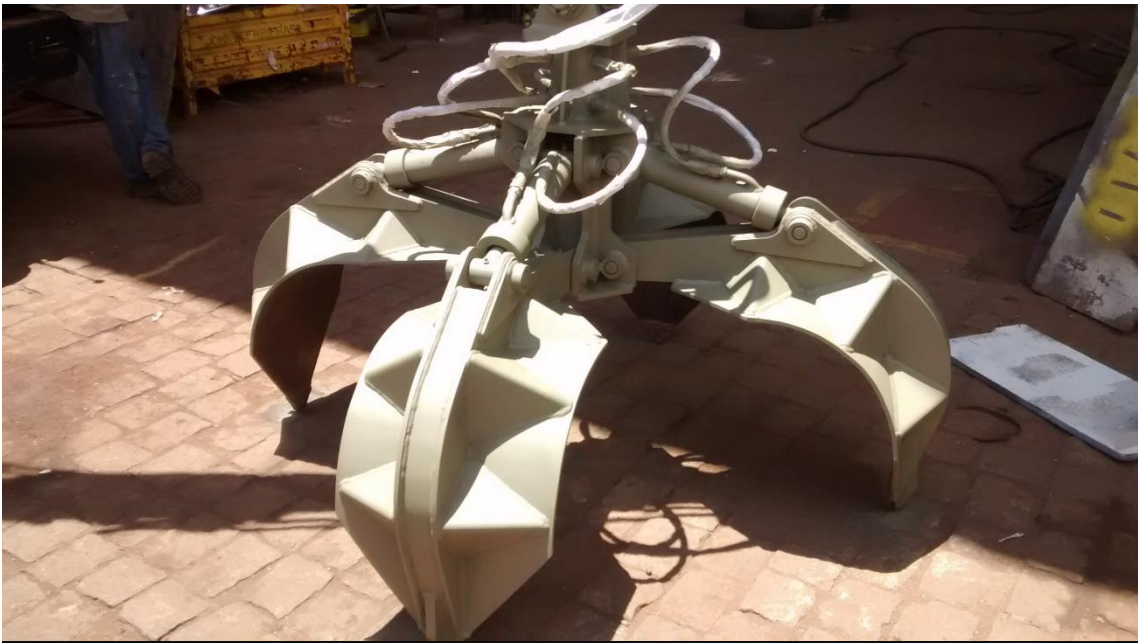

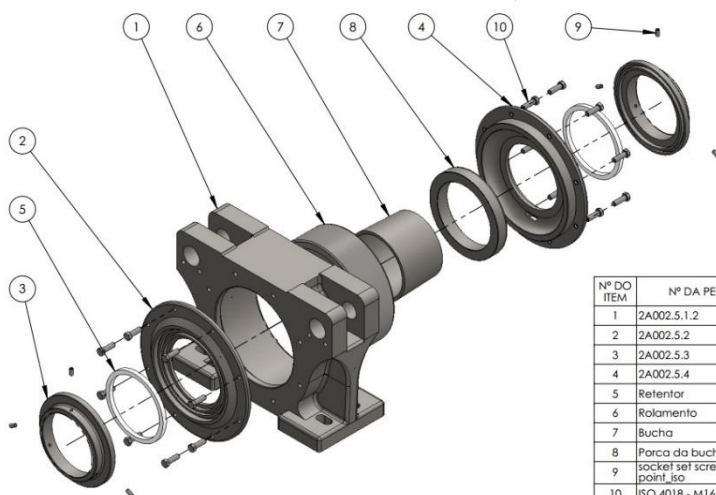

Nº DO ITEM	Nº DA PEÇA	DESCRIÇÃO	QDT.
1	2A002.5.1.2		1
2	2A002.5.2		1
3	2A002.5.3		2
4	2A002.5.4		1
5	Retentor	Retentor mod. A-5, Vedabráis - Nº 27949	2
6	Rolamento	23148 CCK/W33+OH 3148 H	1
7	Bucha		1
8	Porca da bucha		1
9	socket set screw cup point iso		6
10	ISO 4018 - M16 x 50-NC		16

SE NÃO ESPECIFICADO: DIMENSÕES EM MILÍMETROS ACABAM SUPERFÍCIE: TOLERÂNCIAS: LINEAR: ANGULAR:		ACABAMENTO:	REBARBAR E QUEBRAR ARISTAS AGUDAS	NÃO MUDAR A ESCALA DO DESENHO	REVISÃO
DES.	NOME	ASSINATURA	DATA	TÍTULO:	
VERIF.	Moheus		20/04/12		
APROV.			20/04/12		
MANUF.					
QUALID					
			MATERIAL:	DES. Nº	A4
				1 - 2A002.4.1 - Mancal Conjunto - Lado Livre - Montagem Completa	

