

- H1 MountingHole
- H2 MountingHole
- H3 MountingHole
- H4 MountingHole

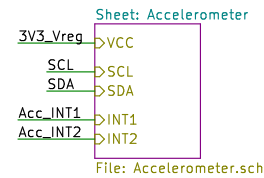

Released under the
 Creative Commons Attribution Share-Alike 4.0 International License

<https://creativecommons.org/licenses/by-sa/4.0/legalcode>

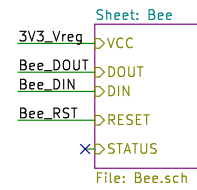
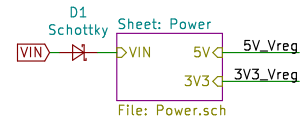
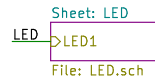
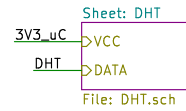
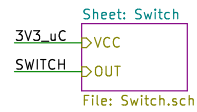
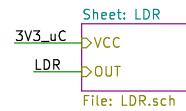

RoboCore

Sheet: /
 File: IoT.DevKit_v1.0.sch

Title: IoT DevKit

Size: A4 Date: 2020-07-10

KiCad E.D.A. kicad (5.1.4)-1

Rev: v1.0

Id: 1/9

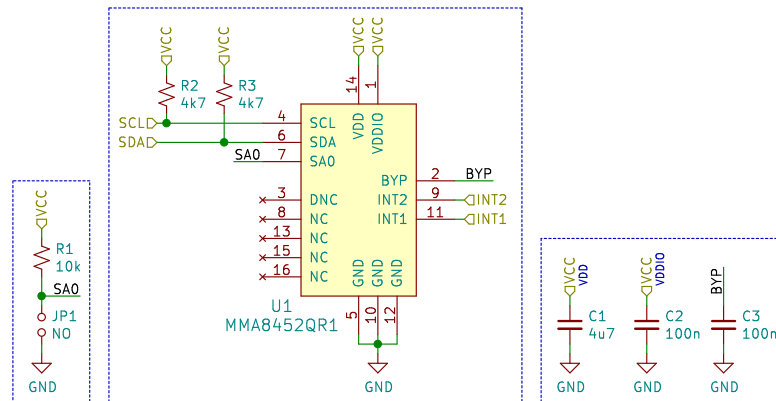

Released under the
Creative Commons Attribution Share-Alike 4.0 International License

<https://creativecommons.org/licenses/by-sa/4.0/legalcode>

ROBOCORE®

RoboCore

Sheet: /Accelerometer/
File: Accelerometer.sch

Title: IoT DevKit

Size: A4 Date: 2020-07-10
KiCad E.D.A. kicad (5.1.4)-1

Rev: v1.0
Id: 2/9

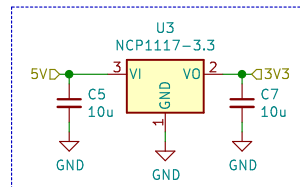
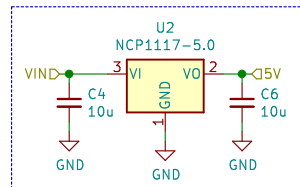

Released under the
Creative Commons Attribution Share-Alike 4.0 International License

<https://creativecommons.org/licenses/by-sa/4.0/legalcode>

ROBOCORE®

RoboCore

Sheet: /Power/
File: Power.sch

Title: IoT DevKit

Size: A4 Date: 2020-07-10
KiCad E.D.A. kicad (5.1.4)-1

Rev: v1.0
Id: 3/9

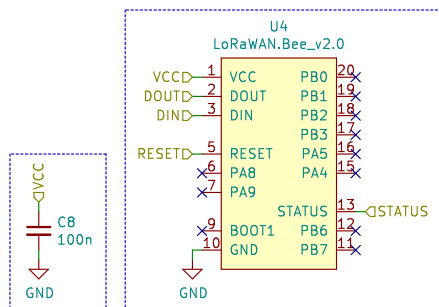

Released under the
Creative Commons Attribution Share-Alike 4.0 International License

<https://creativecommons.org/licenses/by-sa/4.0/legalcode>

ROBOCORE®

RoboCore

Sheet: /Bee/

File: Bee.sch

Title: IoT DevKit

Size: A4 Date: 2020-07-10

KiCad E.D.A. kicad (5.1.4)-1

Rev: v1.0

Id: 4/9

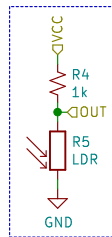

Released under the
Creative Commons Attribution Share-Alike 4.0 International License

<https://creativecommons.org/licenses/by-sa/4.0/legalcode>

ROBOCORE®

RoboCore

Sheet: /LDR/

File: LDR.sch

Title: IoT DevKit

Size: A4 Date: 2020-07-10

KiCad E.D.A. kicad (5.1.4)-1

Rev: v1.0

Id: 5/9

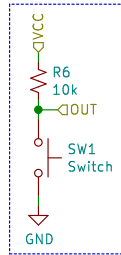

Released under the
Creative Commons Attribution Share-Alike 4.0 International License

<https://creativecommons.org/licenses/by-sa/4.0/legalcode>

ROBOCORE®

RoboCore

Sheet: /Switch/
File: Switch.sch

Title: IoT DevKit

Size: A4 Date: 2020-07-10
KiCad E.D.A. kicad (5.1.4)-1

Rev: v1.0
Id: 6/9

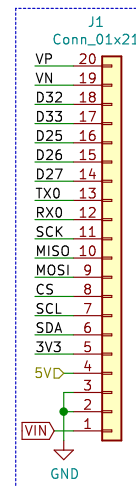
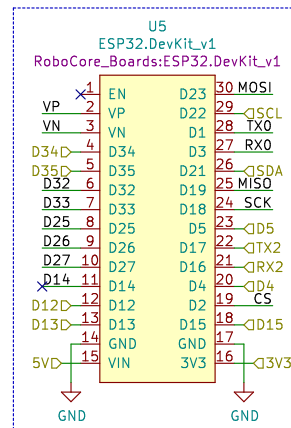

Released under the
Creative Commons Attribution Share-Alike 4.0 International License

<https://creativecommons.org/licenses/by-sa/4.0/legalcode>



RoboCore

Sheet: /Microcontroller/
File: Microcontroller.sch

Title: IoT DevKit

Size: A4 Date: 2020-07-10

KiCad E.D.A. kicad (5.1.4)-1

Rev: v1.0

Id: 7/9

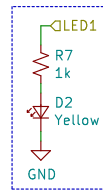

Released under the
Creative Commons Attribution Share-Alike 4.0 International License

<https://creativecommons.org/licenses/by-sa/4.0/legalcode>

ROBOCORE®

RoboCore

Sheet: /LED/

File: LED.sch

Title: IoT DevKit

Size: A4 Date: 2020-07-10

KiCad E.D.A. kicad (5.1.4)-1

Rev: v1.0

Id: 8/9

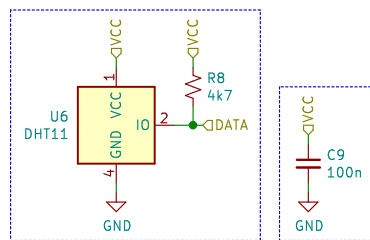

Released under the
Creative Commons Attribution Share-Alike 4.0 International License

<https://creativecommons.org/licenses/by-sa/4.0/legalcode>

ROBOCORE®

RoboCore

Sheet: /DHT/

File: DHT.sch

Title: IoT DevKit

Size: A4 Date: 2020-07-10

KiCad E.D.A. kicad (5.1.4)-1

Rev: v1.0

Id: 9/9